

**CATALOGO
GENERALE
2023**

 **ATHENA**
così in luce



La nostra azienda, presente sul mercato dal 1972 concentra nella propria sede tutte le fasi di lavorazione dei prodotti, dalla progettazione alla costruzione e all'assemblaggio.

La massima professionalità viene impiegata nella creazione e nella produzione dei nostri articoli per garantirne la più accurata qualità e la massima sicurezza. Seguendo tale impegno tutti i nostri prodotti hanno raggiunto la marcatura europea CE attestante la conformità alle norme di sicurezza. Da sempre a fianco della clientela per offrire la massima disponibilità e professionalità ad aiutare a risolvere ogni problematica in campo illuminotecnico e esecuzioni speciali o contract.

Collezioni di lampade da terra, lampade da parete, plafoniere, sospensioni e lampade da tavolo, sistemi su cavo a 220V e 12V. I nuovi sistemi e faretto a incasso a LED completano la gamma della produzione, che arreda ambienti sia moderni che in stile. L'evoluzione della nuova tecnologia LED si concretizza nella produzione di nuove collezioni e nei nuovi sistemi con sorgenti luminose a LED. L'esperienza dei nostri tecnici e designer, la ricerca di nuovi materiali, l'utilizzo delle nuove tecnologie di costruzione caratterizzano l'unicità delle nostre collezioni.

Nella ricerca costante della migliore funzionalità e qualità dei nostri prodotti, si riserva in qualsiasi momento la facoltà di apportare modifiche e migliorie sugli stessi senza alcun obbligo di avviso alla Clientela.

Our firm, on the market since 1972 converges all the manufacturing cycle of its production, from the design to the production and assembly, in its factory.

Great professionalism is used in the creation and production of our products to guarantee top quality and maximum safety.

Following that course, all our products have obtained the European EC mark, certifying their compliance with safety regulations. Always working alongside customers to offer maximum availability and professionalism, helping them find solutions to any problem that may arise in the field of lighting, for special executions or contracts.

Collections of floor lamps, wall lights, ceiling light fixtures, pendants and table lamps that furnish both modern and classical surroundings. Evolution of the new led technology has led to the creation of new collections and new systems using led light sources.

The experience of our technicians and designers, the search for new materials, the use of new manufacturing technologies characterize the unicity of our collections.

In the continuous engagement to improve the performance and quality of our products, we reserve the right to make modifications and improvements to them without prior notice to our Customers.

PROFILI



OMICRON	12
HANGAR	38
SIGMA	46
TRIAx	54
DELTA	56
TAU	62
SIHON	68
SLASH	76
B-LIGHT	84
MINI B-LIGHT	88
MICRO	94
ANGOLARE	98
VELA	102
KAPPA	104
PIATTO	105
OMEGA	106
RESINATI IP67	112
ETHA	118
STRIP FLEX	120

SISTEMI



FOCUS 300	130
FOCUS 160	142
TWIN	150

DECORATIVO



TAG	176
SWING	184
ATLAS	188
LIBRO	196
MODÌ	200
OMICRON	202
SLASH	214
INCROCIO	218
EDERA	228
ALVIN	238
DADAJE	240
GIOTTO	258
DEGAS	270
MONET	282
PICASSO	288
BETA	292

INCASSO



ORIONE	296
PEGASO	305

ACCESSORI



DRIVERS	310
CENTRALINE	314







Simboli e marchi

Symbols and marks

-  **I prodotti sono conformi alle normative EMC**
The product comply with EEC directives.
La marcature CE garantisce la libera circolazione dei prodotti sul mercato europeo.
EEC marking guarantees the free circulation of the products in the European market.
-  **Apparecchi dotati di morsetto di terra o cavo completo di conduttore di terra.**
Equipment with metal parts connected to the earth circuit.
-  **Apparecchi dotati di doppio isolamento e senza dispositivi di messa a terra.**
Equipment with double insulation and without earthing devices.
-  **Apparecchi alimentati con tensione inferiore a 50V.**
Equipment powered with safety voltage lower than 50V.
-  **Apparecchi idonei per essere installati su superfici infiammabili.**
Equipment can be used on inflammable surfaces.
-  **Dimensione del foro di incasso**
Hole dimensions
-  **Peso netto in gr. del prodotto**
Net weight in gr. of the product
-  **Calpestabile**
Walkable
-  **Apparecchio completo di driver**
Device completed with the driver
-  **Apparecchio non fornito di driver**
Device without the driver
-  **Apparecchio completo di dimmer**
Device completed with the dimmer
-  **Dimmer a richiesta**
Dimmer available under request
-  **Durata del prodotto**
Duration of the product
-  **Temperatura**
Temperature
-  **Misura di taglio**
Cutting size
-  **Apparecchio con luce rivolta verso il basso**
Device with the light pointing downward
-  **Apparecchio con luce rivolta verso l'alto**
Device with the light pointing upward
-  **Apparecchio con luce rivolta verso l'alto e il basso**
Device with the light pointing upward and downward
-  **Uso interno parete/soffitto**
Indoor wall/ceiling
-  **Uso interno ed esterno parete/soffitto**
Indoor and outdoor wall/ceiling

Indice protezione IP ...**Resistenza alla penetrazione di solidi (1^ cifra) e liquidi (2^ cifra)**

Protective degree IP ... Resistence of the fitting to the penetration of solid and liquids

- IP 1..  **Protetto contro la penetrazione di corpi solidi di dimensione superiore a 50 mm.**
Protected against penetration of solids larger than 50 mm.
- IP 2..  **Protetto contro la penetrazione di corpi solidi di dimensione superiore a 12 mm.**
Protected against penetration of solids larger than 12 mm.
- IP 3.. **Protetto contro la penetrazione di corpi solidi di dimensione superiore a 2,5 mm.**
Protected against penetration of solids larger than 2,5 mm.
- IP 4.. **Protetto contro la penetrazione di corpi solidi di dimensione superiore a 1 mm.**
Protected against penetration of solids larger than 1 mm.
- IP 5.. **Protetto contro la penetrazione della polvere**
Protected against penetration of dust
- IP 6.. **Protetto completamente contro la penetrazione della polvere**
Completely protected against penetration of dust
- IP ..0 **Non protetto / Unprotected**
- IP ..1 **Protetto contro le cadute verticali di gocce d'acqua**
Protected against vertical falling of water drops
- IP ..2 **Protetto contro la caduta d'acqua con inclinazione max di 15°**
Protected against falling of water with 15° maximum angle
- IP ..3  **Protetto contro la pioggia / Protected against rain**
- IP ..4  **Protetto contro gli spruzzi / Protected against sprinklings**
- IP ..5  **Protetto contro i getti d'acqua / Protected against water jets**
- IP ..6 **Protetto contro le ondate / Protected against heavy waves**
- IP ..7  **Protetto contro l'immersione temporanea**
Protected against temporary immersion

Sezione catalogo

INCASSO | ORIONE

227

Nome collezione

ORIONE

Design Athena

Descrizione prodotto

Faretto da incasso fisso per interno con corpo in ottone. Completo di molle per installazione.
Indoor fixed recessed metal spot light. Copper structure. Springs included.

Foto prodotto

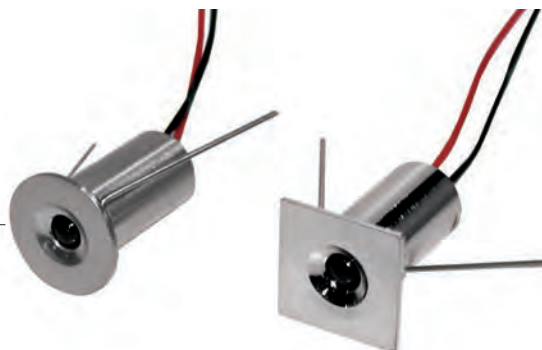

Collegamento in parallelo.
Parallel connection.

Caratteristiche tecniche prodotto

FARETTO INCASSO TONDO LED **1x0,5W - 24Vdc 20mA**

Codice prodotto, finiture, Led

Code	Color	Led	Optic
11301	1 Chrome 2 Nickel 5 White	1 Natural White 6 Warm White 2 Blue 4 Green 8 Red 9 RGB	120°

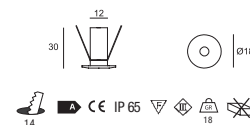

Marchi e simboli

FARETTO INCASSO QUADRO LED **1x0,5W - 24Vdc 20mA**

Code	Color	Led	Optic
11311	1 Chrome 2 Nickel 5 White	1 Natural White 6 Warm White 2 Blue 4 Green 8 Red 9 RGB	120°

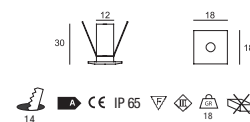

Accessori

DRIVERS

Utilizzare alimentatori 24Vdc pag 244
Use DRIVERS 24Vdc page 244

ACCESSORI

1130
Cassaforma + OR
Mould + OR
Ø 16x35

**COMPOSIZIONE CODICE PRODOTTO - da utilizzare in fase d'ordine**

FARETTO ORIENTABILE LED
5,8 W 12Vdc

Code	Color	Led	Polycarbonate
0357	1 Chrome	1 4000°K - 920 lm 6 3000°K - 848 lm	1 Trasparent

Codice: **0357.1.6.1** faretto cromo - warm white - policarbonato trasparente

PROFILI E STRIP | PROFILES AND STRIP LED

PROFILI LED | LED PROFILES



ETHA 118

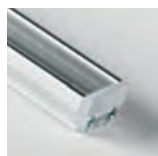

DELTA 56



OMICRON PL 12

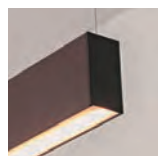

OMICRON SO 26



OMEGA WET 106



MICRO 94



RESINATI 112



SIGMA 46

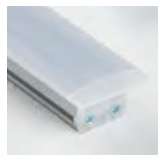

SIHON 68

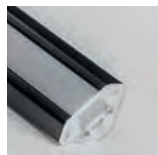

TAU 62



HANGAR 38



ANGOLARE 98



SLASH 76



MINI B-LIGHT 88

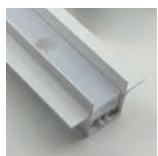

HANGAR 38



OMICRON 14

PROFILI | PROFILES

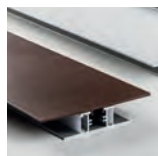

B-LIGHT 84

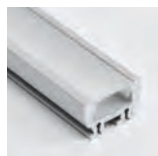

DELTA 56

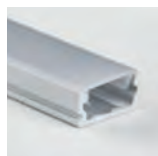

MICRO 94



KAPPA 104



OMEGA 106

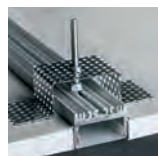

SIGMA 3 52



SIGMA 46

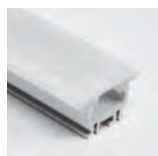

SIHON 68



TAU 62



PIATTO 105

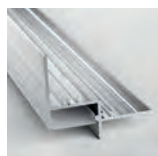

VELA 102



HANGAR 38

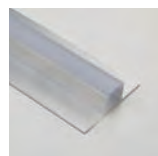

TRIAx 54



SLASH 76



MINI B-LIGHT 88

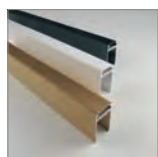

OMICRON 32

STRIP LED | STRIP LED

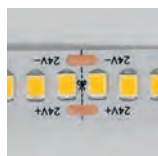

20,2 120

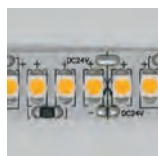

19,2 121



DYN. WHITE 126



RGB+WHITE 126



14,4 122



9,6 124



4,8 125



IP67 127

SISTEMI | SYSTEMS

FOCUS 300

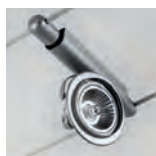

0211 139

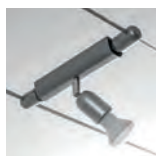

0272 0282 137



0240 135



0234 0251 138



0289 131



0290 133

FOCUS 160



0434 0435 147



0457 143



0458 144



0472 146



0490 145

TWIN



0353 158



0354 161

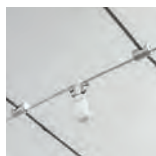

0355 159

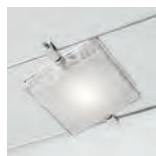

0357 151

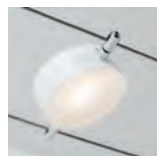

0358 153

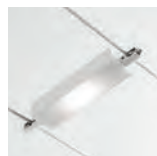

0360 154



0361 0362 155

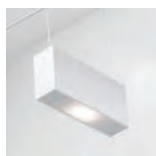

0363 157



1410 165



3110 162



3310 163



0631 167



0635 168



0639 169



0640 169

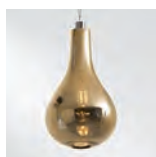

0644 168



0646 168



0647 167



0648 167



0649 169

DECORATIVO | DECORATIVO

PARETE | WALL FIXTURES



ALVIN 238



BETA 293



BETA 293



DADAJÈ 240



DADAJÈ 242



DADAJÈ 243



DADAJÈ 255



DADAJÈ 255

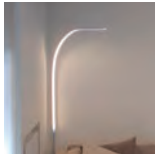

DEGAS 276



ATLAS 188



GIOTTO 265



GIOTTO 266



INCROCIO 218



INCROCIO 220



LIBRO 199



MODÌ 200



OMICRON 207



OMICRON 210



PICASSO 288

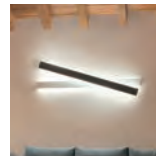

SLASH 214

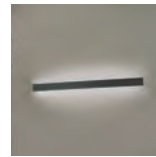

SLASH 216



SWING 186



TAG 178



TAG 181

SOFFITTO | CEILING FIXTURES



DADAJÈ 243



DADAJÈ 248



DADAJÈ 245



DADAJÈ 255

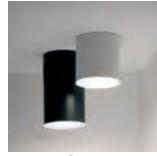

DADAJÈ 253

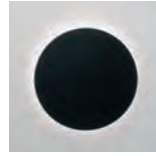

ATLAS 188

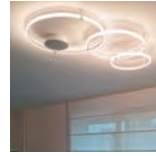

GIOTTO 266



GIOTTO 269



INCROCIO 218

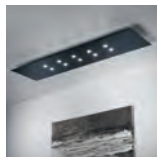

MONET 282



OMICRON 205

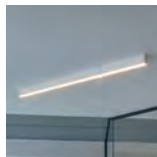

OMICRON 202

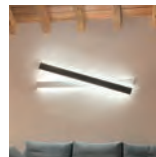

SLASH 214

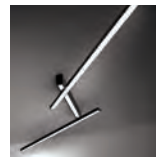

SWING 185

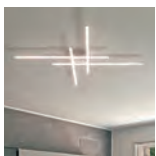

TAG 177

TERRA | FLOOR FIXTURES

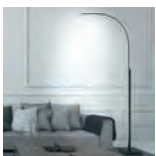

DEGAS 276

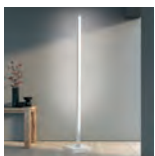

DEGAS 279



MODÌ 201

TAVOLO | TABLE FIXTURES



BETA 292



DADAJÈ 246

DECORATIVO | DECORATIVO

SOSPENSIONI | SUSPENSIONS

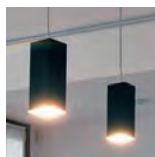

DADAJÈ 250



DADAJÈ 256



DEGAS 270

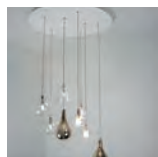

EDERA 228



GIOTTO 258



INCROCIO 226



MONET 284



OMICRON 209

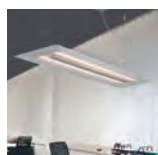

TAG 182

FARETTI | SPOT



BETA 293



BETA 293



DADAJÈ 242



DADAJÈ 243



DADAJÈ 255



DADAJÈ 255



OMICRON 207

INCASSO | RECESSED SPOTS



1008 305



1010 306



1011 307



1038 305



1040 306



1041 307

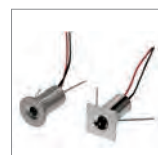

11301 297



11302 298



11303 299



11304 300



11481 302



11501 303



11511 303



11521 304



11531 304

PROFILI

OMICRON

HANGAR

SIGMA

TRIAX

DELTA

TAU

SIHON

SLASH

B-LIGHT

MINI B-LIGHT

MICRO

ANGOLARE

VELA

KAPPA

PIATTO

OMEGA

RESINATI IP67

ETHA

STRIP FLEX

Profili

OMICRON LED PLAFONE

Design Athena

Sistema modulare in alluminio verniciato completo di policarbonato PMMA. Disponibile nelle finiture oro, corten, bianco, ardesia, grigio e nero. Gli accessori in dotazione permettono di comporre il sistema in varie soluzioni. I moduli vengono tagliati a misura secondo le esigenze del cliente e forniti completi di led. Alimentatori e accessori di dimmerazione vengono inseriti direttamente nel profilo. Tappi, drivers e accessori da ordinare separatamente in funzione del sistema da comporre. Completano il sistema i moduli completi di Led con lente e i moduli con faretti.

Alluminium modular painted profiles completed with polycarbonate PMMA. It is available in gold, corten, white, dark grey, grey and black finishes. The attached accessories give the possibility to compose the system in various solutions. The modules are custom cut to meet the needs of the clients and are already sold with Leds. Power supplies and accessories are placed directly inside the profile. Caps, drivers and accessories are to be ordered separately based on the system to be composed. The system is completed by modules complete with Leds with lenses and modules with spotlights.

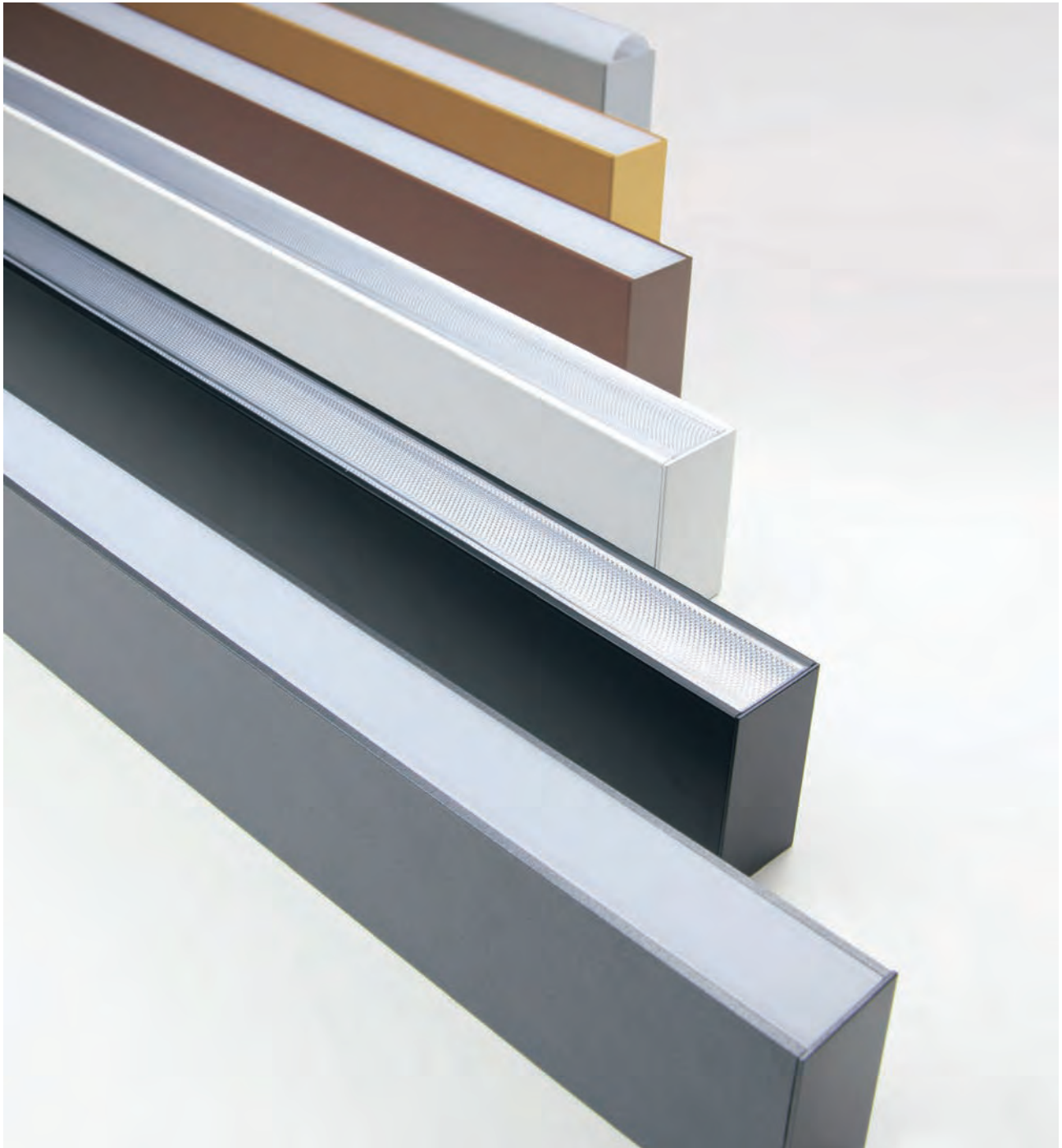

MODULI A PLAFONE TAGLIATI A MISURA COMPLETI DI LED

Il codice del prodotto è riferito a 10 cm di modulo completo di led. Per definire la lunghezza finale del modulo considerare la misura di taglio del led.

Composizione Codice: modulo 1 linea led - bianco - WW - schermo satinato = 98210109.5.6.1 cm.

TAILORED CUT CEILING FIXTURES WITH LED

The code of the product is referred to 10 cm of it. To define the final length of the ceiling module consider the cut measure of the led.

Code Composition: profile 1 led line - White - WW - satin screen = 98210109.5.6.1 cm.

OMICRON LED PLAFONE MODULARE

Modulo composto da: profilo in alluminio, Led e schermo in policarbonato. A richiesta è possibile inserire la strip Led IP64 dentro i profili.
Tappi, drivers e accessori da ordinare separatamente.

Profile, Led and polycarbonate PMMA screen included. On demand it is possible to insert strip Led IP64 into profiles.

Dead ends, drivers and accessories must be ordered separately.



Watt/m	1 Linea Led	2 Linee Led	Color	Led
	Code - 10 cm	Code - 10cm		
19,2	98210109	98210209	3 Gold	1 4000°K
20,2	98310109	98310209	4 Corten	6 3000°K
14,4	98410109	98410209	5 White	8 2700°K
			6 Ardesia	
			7 Grey	
			9 Black	

Code	Linee x	Led/mt	Lm/mt	Lm/mt	Lm/mt	Code	Linee x	Led/mt	Lm/mt	Lm/mt	Lm/mt
1 LINEA	W/mt		4000°K	3000°K	2700°K	2 LINEE	W/mt		4000°K	3000°K	2700°K
98210109	1x19,2	240	1580	1540	1490	98210209	2x19,2	480	3160	3080	2980
98310109	1x20,2	224	3114	2937	2740	98310209	2x20,2	448	6228	5874	5480
98410109	1x14,4	140	1947	1836	1712	98410209	2x14,4	240	3894	3672	3424

24 Vdc CRI90 SDCM3 30.000h -20° +40° 14,4 5,1 cm - 19,2 2,5 cm - 20,2 3,57 cm

SCHERMI



1 Satinato 4 Curvo 5 Prismatico

ACCESSORI Elenco completo accessori pag 18



9895

Utilizzabile solo con schermo prismatico e profili con una linea Led.
Use only with prismatic screen and profiles with 1 line Led.

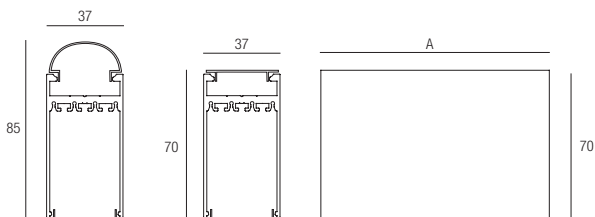

A: Color: 3 max cm 200 - 4-5-6-7-9 max cm 300

Led CRI >90 IP 40



OMICRON PLAFONE MODULARE

Moduli composti da: profilo in alluminio, Led con lente. Drivers, tappi e accessori da ordinare separatamente.
 Modules consisting of: aluminum profile, Led with lenses. Drivers, caps and accessories to be ordered separately.

OMICRON SL3 / SL6
 Modulo 3 o 6 Led fissi - Module 3/6 fixed Led
9/18w tot 24Vdc 720/1440 lm tot

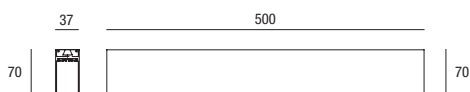

Code - 3 luci	Color	Led	Ottica
98212109	3 Gold	1 4000°K	1 25°
	4 Corten	6 3000°K	6 60°
	5 White		
Code - 6 luci			
98212209	6 Ardesia		
	7 Grey		
	9 Black		

Color: 3-4-5-6-7 policarbonato satinato
 Color: 9 policarbonato nero



OMICRON SLO6
 Modulo 6 Led orientabili - Module 6 adjustable Led
18w tot 24Vdc 1440 lm tot

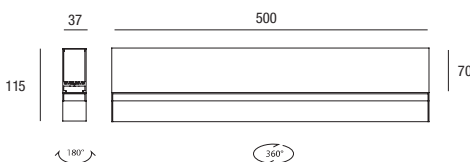

Code	Color	Led	Ottica
98212309	3 Gold	1 4000°K	1 25°
	4 Corten	6 3000°K	6 60°
	5 White		
6 Ardesia			
7 Grey			
9 Black			

Color: 3-4-5-6-7 policarbonato satinato
 Color: 9 policarbonato nero



OMICRON SL
 Modulo con 1 o 2 linee Led orientabili
 Module with 1 or 2 adjustable Led lines

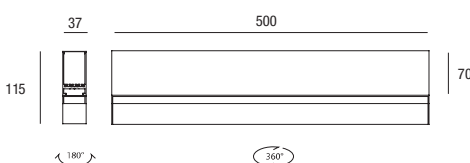

1 Linea Led	2 Linee Led	Color	Led
Code	Code		
98211909	98212009	3 Gold	1 4000°K
		4 Corten	6 3000°K
		5 White	8 2700°K
		6 Ardesia	
		7 Grey	
		9 Black	

Code	Watt	Lumen	Lumen	Lumen
1 LINEA		4000°K	3000°K	2700°K
98211909	9,5	1445	1365	1272

Code	Watt	Lumen	Lumen	Lumen
2 LINEE		4000°K	3000°K	2700°K
98212009	19	2890	2730	2540



OMICRON SLO3

Modulo 3 Led orientabili - Module 3 adjustable Led
3x3w tot 24Vdc 720 lm tot

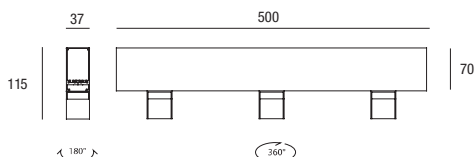

Code	Color	Led	Ottica
98212409	3 Gold	1 4000°K	1 25°
	4 Corten	6 3000°K	6 60°
	5 White		
	6 Ardesia		
	7 Grey		
	9 Black		
	Color: 3-4-5-6-7 policarbonato satinato		
	Color: 9 policarbonato nero		



OMICRON SLO 4

Modulo 2+2 Led orientabili - Module 2+2 adjustable Led
4x3w tot 24Vdc 960 lm tot

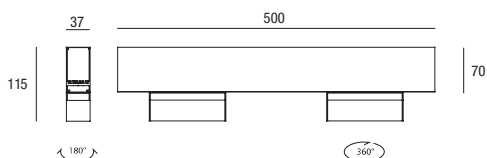

Code	Color	Led	Ottica
98212509	3 Gold	1 4000°K	1 25°
	4 Corten	6 3000°K	6 60°
	5 White		
	6 Ardesia		
	7 Grey		
	9 Black		
	Color: 3-4-5-6-7 policarbonato satinato		
	Color: 9 policarbonato nero		



OMICRON F02 / F03

Modulo 2 o 3 faretti GU10 orientabili - Module 2/3 GU10 adjustable spotlight
2 / 3 GU10 (lampadine NON INCLUSE)

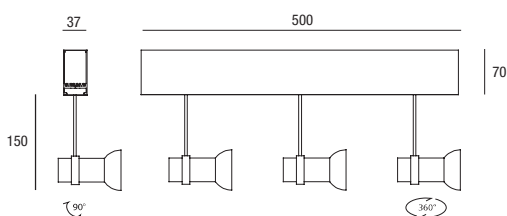
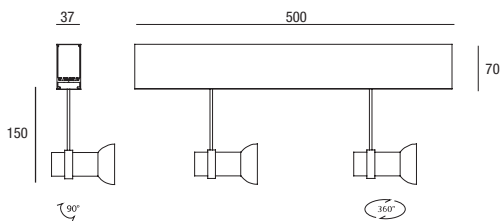

Code - 2 luci	Color
98212609	3 Gold
	4 Corten
	5 White
Code - 3 luci	6 Ardesia
	7 Grey
	98212709



Esempio di composizione a soffitto



OMICRON CON FORI PER SOSPENSIONI
 Modulo con 2 o 3 fori per sospensioni (NON INCLUSE)
 Module with 2/3 holes for suspensions (NOT INCLUDED)

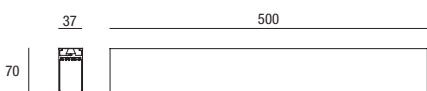

Code - 2 fori	Color
98212809	3 Gold
	4 Corten
	5 White
Code - 3 fori	6 Ardesia
	7 Grey
98212909	9 Black



OMICRON SO
 Sospensione Led per modulo con fori (non incluso)
 1 GU10 (Lampadina non inclusa)
 Led suspension for module with holes (not included)

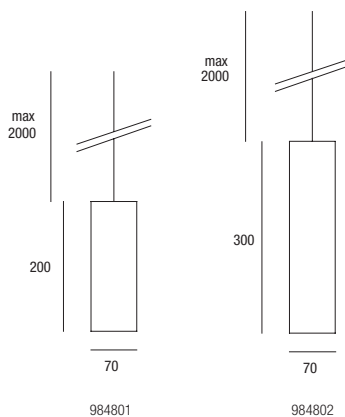
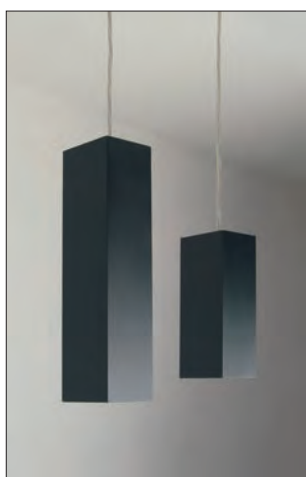

Code	Color	Lamp
984801	3 Gold	1 GU 10 Led
	4 Corten	
	5 White	
Code	6 Ardesia	
	7 Grey	
984802	9 Black	



ACCESSORI OMICRON PLAFONE MODULARE

UGR<19

UGR<19 in funzione dell'installazione.
Utilizzabile solo con schermo prismatico e profili con una linea Led.
Fornito già assemblato nel modulo.

UGR<19 depending on installation.
Use only with prismatic screen and profiles with 1 line Led.
Already assembled into the module.

Code cm 10**9895**

Tappo piatto
Flat dead end

Code**Color****9851**

- | | | |
|----------|--|---------|
| 3 | | Gold |
| 4 | | Corten |
| 5 | | White |
| 6 | | Ardesia |
| 7 | | Grey |
| 9 | | Black |



Tappo curvo
Curved flat end

Code**Color****9852**

- | | | |
|----------|--|---------|
| 3 | | Gold |
| 4 | | Corten |
| 5 | | White |
| 6 | | Ardesia |
| 7 | | Grey |
| 9 | | Black |



Kit plafone
Ceiling Kit

Code**9853**

Kit Congiunzione
Junction Kit

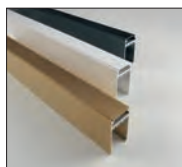
Code**9854**

Modulo a plafone senza Led con copertura in metallo verniciato.
Ceiling module without Led, with painted metal cover.

Code - 50 cm**Code - 100 cm****Color****98210091****98210092**

- | | | |
|----------|--|---------|
| 3 | | Gold |
| 4 | | Corten |
| 5 | | White |
| 6 | | Ardesia |
| 7 | | Grey |
| 9 | | Black |

37

500 / 1000

70



70



Curva 90° orizzontale senza Led con copertina in metallo verniciato
 90° Horizontal corner without Led, with painted metal cover



170



Code

Color

98210011



- 3** Gold
- 4** Corten
- 5** White
- 6** Ardesia
- 7** Grey
- 9** Black

Curva 90° orizzontale con Led
 90° Horizontal corner with Led



170



Watt/m	1 Linea Led Code	2 Linee Led Code	Color	Led
19,2	98210111	98210211	3 Gold	1 4000°K
20,2	98310111	98310211	4 Corten	6 3000°K
14,4	98410111	98410211	5 White	8 2700°K
			6 Ardesia	
			7 Grey	
			9 Black	



Code	Watt	Lumen 4000°K	Lumen 3000°K	Lumen 2700°K	Gr
98210111	5,7	474	462	447	342
98310111	5,8	888	832	776	342
98410111	4,3	584	552	514	342

Code	Watt	Lumen 4000°K	Lumen 3000°K	Lumen 2700°K	Gr
98210211	10,6	849	847	820	356
98310211	11,6	1776	1664	1553	356
98410211	8	1070	1010	942	356



ACCESSORI OMICRON PLAFONE MODULARE

Curva 90° verticale senza Led con copertura in metallo verniciato
90° vertical corner without Led, with painted metal cover



170



Code

Color

98210012



- 3 Gold
- 4 Corten
- 5 White
- 6 Ardesia
- 7 Grey
- 9 Black

Curva 90° verticale luce IN completa di Led
90° Vertical corner light IN with Led



170



Watt/m	1 Linea Led Code	2 Linee Led Code	Color	Led
19,2	98210112	98210212	3 Gold	1 4000°K
20,2	98310112	98310212	4 Corten	6 3000°K
14,4	98410112	98410212	5 White	8 2700°K
			6 Ardesia	
			7 Grey	
			9 Black	

Code	Watt	Lumen 4000°K	Lumen 3000°K	Lumen 2700°K	Gr	Code	Watt	Lumen 4000°K	Lumen 3000°K	Lumen 2700°K	Gr
1 LINEA						2 LINEE					
98210112	3,9	316	308	298	280	98210212	7,7	632	616	596	290
98310112	4,4	666	624	582	280	98310212	8,8	1332	1248	1165	290
98410112	2,9	390	368	342	280	98410212	5,8	780	736	684	290

Curva 90° verticale luce OUT completa di Led
90° Vertical corner light OUT with Led



170



Watt/m	1 Linea Led Code	2 Linee Led Code	Color	Led
19,2	98210113	98210213	3 Gold	1 4000°K
20,2	98310113	98310213	4 Corten	6 3000°K
14,4	98410113	98410213	5 White	8 2700°K
			6 Ardesia	
			7 Grey	
			9 Black	

Code	Watt	Lumen 4000°K	Lumen 3000°K	Lumen 2700°K	Gr	Code	Watt	Lumen 4000°K	Lumen 3000°K	Lumen 2700°K	Gr
1 LINEA						2 LINEE					
98210113	5,7	474	462	447	372	98210213	11,4	948	924	894	386
98310113	5,8	888	832	776	372	98310213	11,6	1776	1664	1552	386
98410113	4,3	584	552	514	372	98410213	8,6	1168	1104	1028	386



ACCESSORI OMICRON PLAFONE MODULARE

Congiunzione a "T" senza Led con copertura in metallo verniciato
"T" junction without Led, with painted metal cover

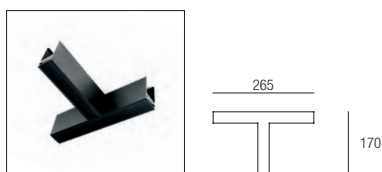

Code

98210014



Color

- 3 Gold
- 4 Corten
- 5 White
- 6 Ardesia
- 7 Grey
- 9 Black

Congiunzione a "T" completa di Led
"T" junction with Led

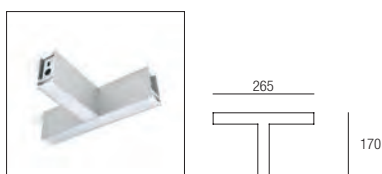

Watt/m

19,2
20,2
14,4

1 Linea Led

Code
98210114
98310114
98410114

2 Linee Led

Code
98210214
98310214
98410214

Color

- 3 Gold
- 4 Corten
- 5 White
- 6 Ardesia
- 7 Grey
- 9 Black

Led

1 4000°K
6 3000°K
8 2700°K

Code	Watt	Lumen			Gr	Code	Watt	Lumen			Gr
		4000°K	3000°K	2700°K				4000°K	3000°K	2700°K	
98210114	7,2	593	578	560	486	98210214	14,4	1186	1156	1120	500
98310114	7,2	1112	1050	980	486	98310214	14,4	2224	2100	1960	500
98410114	5	682	642	600	486	98410214	10	1364	1284	1200	500

Congiunzione a "CROCE" senza Led con copertura in metallo verniciato
"CROSS" junction without Led, with painted metal cover

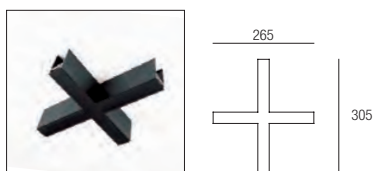

Code

98210018



Color

- 3 Gold
- 4 Corten
- 5 White
- 6 Ardesia
- 7 Grey
- 9 Black

Congiunzione a "CROCE" completa di Led
"CROSS" junction with Led

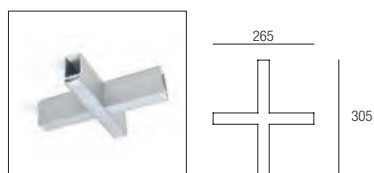

Watt/m

19,2
20,2
14,4

1 Linea Led

Code
98210118
98310118
98410118

2 Linee Led

Code
98210218
98310218
98410218

Color

- 3 Gold
- 4 Corten
- 5 White
- 6 Ardesia
- 7 Grey
- 9 Black

Led

1 4000°K
6 3000°K
8 2700°K

Code	Watt	Lumen			Gr	Code	Watt	Lumen			Gr
		4000°K	3000°K	2700°K				4000°K	3000°K	2700°K	
98210118	9,6	790	770	745	650	98210218	19,2	1580	1540	1480	670
98310118	9,4	1445	1362	1270	650	98310218	18,4	2890	2724	2540	670
98410118	6,5	876	826	770	650	98410218	13	1752	1652	1540	670



ALIMENTATORI inseribili nei moduli a plafone
DRIVERS to insert into ceiling modules

Code

1240	max 20W	24Vdc
1241	max 35W	24Vdc
1242	max 60W	24Vdc
1201	max 75W	24Vdc
1181	max 150W	24Vdc

CENTRALINE PER DIMMERAZIONE inseribili nei moduli a plafone
DIMMABLE DRIVERS to insert into ceiling modules

Code

1260	3x60W	DALI - 0-10V - PUSH
1300	240W	PUSH - 0-10V - 1-10V
1303	240W	CASAMBI - PUSH
1304	240W	DALI - PUSH - 0-10V - 1-10V
1306	190W	PUSH
1308	190W	RF - PUSH+TELECOMANDO 4 zone
1309	190W	RF - PUSH+PULSANTE wireless
1311	2x120W	RF - PUSH (2CH) - APP TUYA - ALEXA - AMAZON ECHO

Grafico composizione sistema
System composition

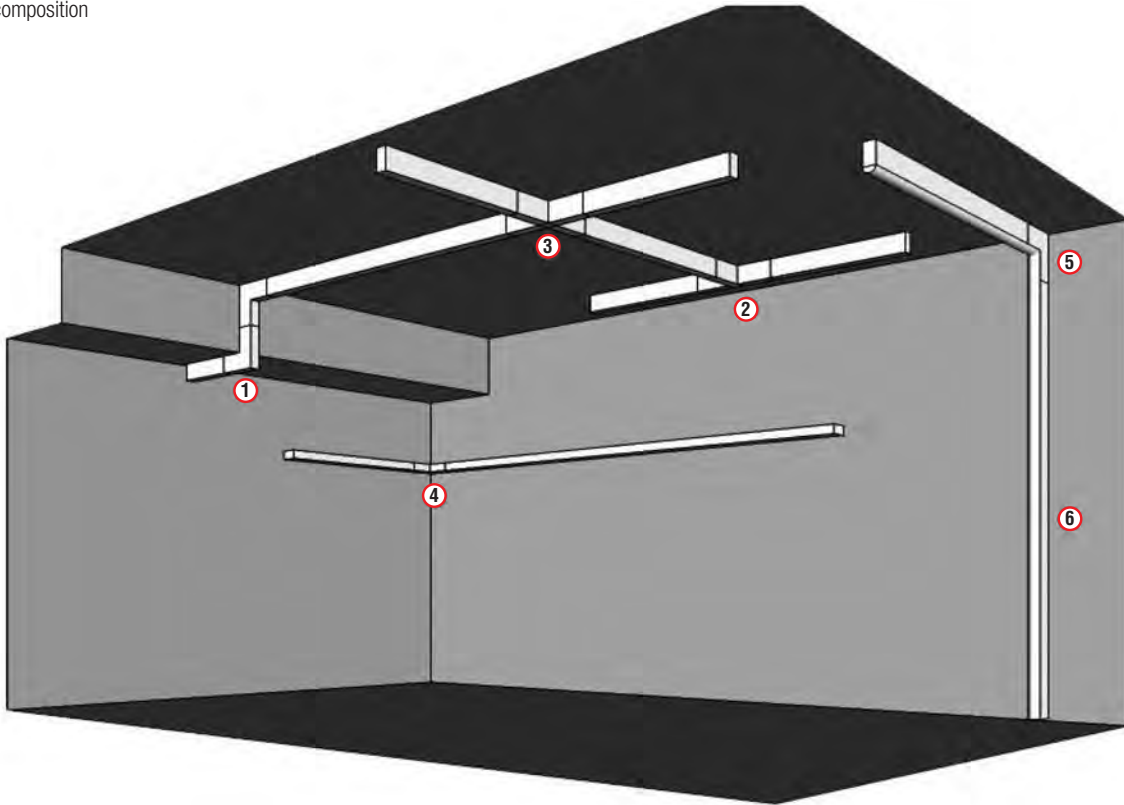

① Curva 90° Verticale luce OUT
90° vertical corner light OUT
98210113 - 98210213
98310113 - 98310213
98410113 - 98410213

② Congiunzione a "T" chiusa
T junction
98210014

② Congiunzione a "T"
T junction
98210114 - 98210214
98310114 - 98310214
98410114 - 98410214

③ Congiunzione a "croce" chiusa
Cross junction
98210018

③ Congiunzione a "CROCE"
Cross junction
98210118 - 98210218
98310118 - 98310218
98410118 - 98410218

④ Curva 90° orizzontale chiusa
90° horizontal corner
98210011

④ Curva 90° orizzontale
90° horizontal corner
98210111 - 98210211
98310111 - 98310211
98410111 - 98410211

⑤ Curva 90° verticale chiusa
90° closed vertical corner
98210012

⑤ Curva 90° verticale luce IN
90° vertical corner light IN
98210112 - 98210212
98310112 - 98310212
98410112 - 98410212

⑥ Moduli a plafone con sorgenti luminose
Ceiling modules with light sources

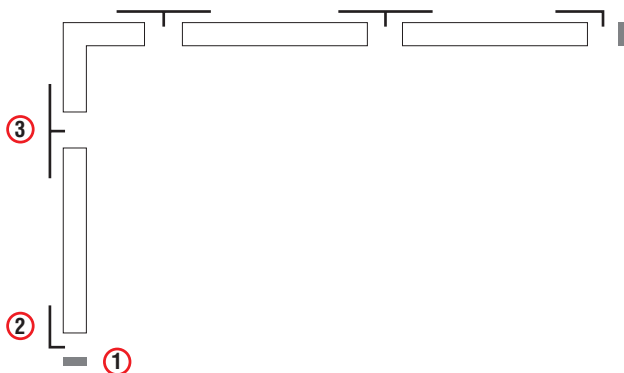

① **9851 - 9852**
Tappo - Dead end

② **9853**
Kit Plafone - Ceiling kit

③ **9854**
Kit congiunzione - Junction kit



BROT.TO



OMICRON LED SOSPENSIONE

Sistema modulare a sospensione in alluminio verniciato. Disponibile nelle finiture oro, corten, bianco, ardesia, grigio e nero. Gli accessori in dotazione permettono di comporre il sistema in varie soluzioni. I moduli vengono forniti completi di Led. Alimentatori e accessori di dimmerazione vengono inseriti direttamente nel profilo. Alimentatori, tappi e accessori da ordinare separatamente in funzione del sistema da comporre.

Painted aluminium modular suspension system. It is available in gold, corten, white, dark grey, grey and black finishes. Supplied accessories allow the system to be composed in various solutions. Modules supplied complete with Leds. Power supplies and dimming accessories are inserted directly into the profile. Drivers, caps and accessories to be ordered separately according to the system to be composed.

Modulo composto da: profilo alluminio, Led, due kit sospensione e schermo in policarbonato PMMA.

Profile, Led, two suspension kit and polycarbonate PMMA screen included.

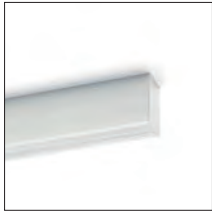

Watt/m	1 Linea Led	2 Linee Led	Color	Led
	Code - 10 cm	Code - 10 cm		
19,2	98510109	98510209	3 Gold	1 4000°K
20,2	98710109	98710209	4 Corten	6 3000°K
14,4	98810109	98810209	5 White	8 2700°K
			6 Ardesia	
			7 Grey	
			9 Black	

Watt/m	1+1 Linea Led	1+2 Linee Led	Color	Led
	Code - 10 cm	Code - 10 cm		
19,2	98511109	98511209	3 Gold	1 4000°K
20,2	98711109	98711209	4 Corten	6 3000°K
14,4	98811109	98811209	5 White	8 2700°K
			6 Ardesia	
			7 Grey	
			9 Black	

Code	Linee x	Led/mt	Lm/mt	Lm/mt	Lm/mt	Code	Linee x	Led/mt	Lm/mt	Lm/mt	Lm/mt
1 LINEA	W/mt		4000°K	3000°K	2700°K	2 LINEE	W/mt		4000°K	3000°K	2700°K
98510109	1x19,2	240	1580	1540	1490	98510209	2x19,2	480	3160	3080	2980
98710109	1x20,2	224	3114	2937	2740	98710209	2x20,2	448	6228	5874	5480
98810109	1x14,4	140	1947	1836	1712	98810209	2x14,4	280	3894	3672	3424

Code	Linee x	Led/mt	Lm/mt	Lm/mt	Lm/mt	Code	Linee x	Led/mt	Lm/mt	Lm/mt	Lm/mt
1+1 LINEA	W/mt		4000°K	3000°K	2700°K	1+2 LINEE	W/mt		4000°K	3000°K	2700°K
98511109	1+1x19,2	240+240	1580+1580	1540+1540	1490+1490	98511209	1+2x19,2	240+480	1580+3160	1540+3080	1490+2980
98711109	1+1x20,2	224+224	3114+3114	2937+2937	2740+2740	98711209	1+2x20,2	224+448	3114+6228	2937+5874	2740+5480
98811109	1+1x14,4	140+140	1947+1947	1836+1836	1712+1712	98811209	1+2x14,4	140+280	1947+3894	1836+3672	1712+3424

24 Vdc CRI90 E/F SDCM3 30.000h -20°+40° 14,4 5,1 cm - 19,2 2,5 cm - 20,2 3,57 cm

SOSPENSIONI TAGLIATE A MISURA COMPLETE DI LED

Il codice del prodotto è riferito a 10 cm di sospensione completa di Led.

Per definire la lunghezza finale della sospensione considerare la misura del taglio Led.

TAILORED CUT SUSPENSIONS WITH LED

The code of the product is referred to 10 cm of it

To define the final length of the suspension consider the cut measure of the Led.



SCHERMI



1 Satinato

4 Curvo

5 Prismatico

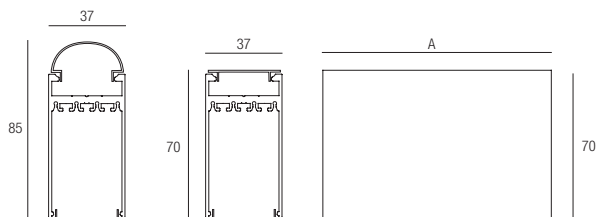

A: Color: **3** max cm 200 - **4-5-6-7-9** max cm 300

ACCESSORI Elenco completo accessori pag 32

UGR<19

9895

Utilizzabile solo con schermo prismatico e profili con una linea Led.
Use only with prismatic screen and profiles with 1 line Led.

Led CRI >90 **E/F** **CE** IP 40



OMICRON SOSPENSIONE MODULARE

Moduli composti da: profilo in alluminio, Led con lente. Drivers, tappi e accessori da ordinare separatamente.

Modules consisting of: aluminum profile, Led with lens. Drivers, caps and accessories to be ordered separately.

OMICRON SL3 / SL6

Modulo 3 o 6 Led fissi - Module 3/6 fixed Led

9/18w tot 24Vdc 720/1440 lm tot

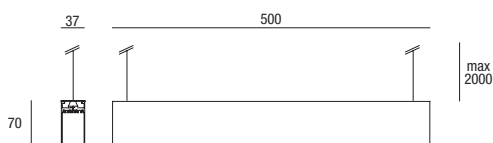

Code - 3 luci	Color	Led	Ottica
98512109	3 Gold	1 4000°K	1 25°
	4 Corten	6 3000°K	6 60°
	5 White		
Code - 6 luci			
98512209	6 Ardesia		
	7 Grey		
	9 Black		
	Color: 3-4-5-6-7 policarbonato satinato Color: 9 policarbonato nero		

Led CRI >80 E V CE IP 40

 GR 610 GR 730

OMICRON SLO6

Modulo 6 Led orientabili - Module 6 adjustable Led

18w tot 24Vdc 1440 lm tot

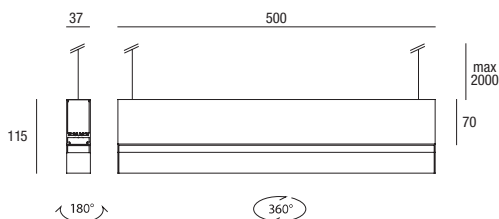

Code	Color	Led	Ottica
98512309	3 Gold	1 4000°K	1 25°
	4 Corten	6 3000°K	6 60°
	5 White		
	6 Ardesia		
	7 Grey		
	9 Black		
Color: 3-4-5-6-7 policarbonato satinato Color: 9 policarbonato nero			

Led CRI >80 E V CE IP 40

 GR 1200

OMICRON SLO3

Modulo 3 Led orientabili - Module 3 adjustable Led

9w tot 24Vdc 720 lm tot

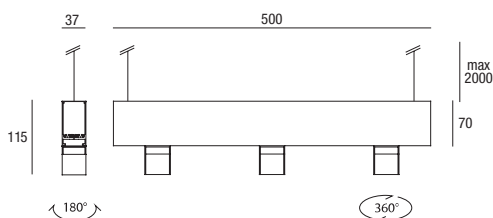

Code	Color	Led	Ottica
98512409	3 Gold	1 4000°K	1 25°
	4 Corten	6 3000°K	6 60°
	5 White		
	6 Ardesia		
	7 Grey		
	9 Black		
Color: 3-4-5-6-7 policarbonato satinato Color: 9 policarbonato nero			

Led CRI >80 E V CE IP 40

 GR 930

OMICRON SLO 4

Modulo 2+2 Led orientabili - Module 2+2 adjustable Led
12w tot 24Vdc 960 lm tot

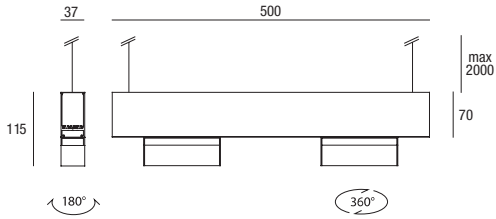

Code	Color	Led	Ottica
98512509	3 Gold	1 4000°K	1 25°
	4 Corten	6 3000°K	6 60°
	5 White		
	6 Ardesia		
	7 Grey		
	9 Black		
	Color: 3-4-5-6-7 plc satinato		
	Color: 9 plc nero		



OMICRON SL

Modulo con 1 o 2 linee Led orientabili - Module with 1 or 2 djustable Led lines

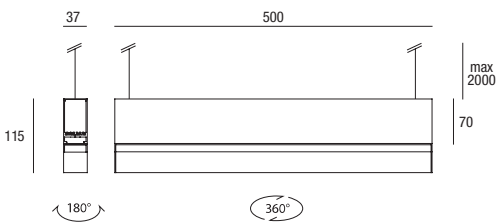

1 Linea Led	2 Linee Led	Color	Led
Code	Code		
98511909	98512009	3 Gold	1 4000°K
		4 Corten	6 3000°K
		5 White	8 2700°K
		6 Ardesia	
		7 Grey	
		9 Black	

Code	Watt	Lumen	Lumen	Lumen
1 LINEA		4000°K	3000°K	2700°K
98511909	9,5	1445	1365	1272

Code	Watt	Lumen	Lumen	Lumen
2 LINEE		4000°K	3000°K	2700°K
98512009	19	2890	2730	2540



OMICRON F02 / F03

Modulo 2 o 3 faretto GU10 orientabili - Module 2/2 GU10 adjustable spotlights.
2/3 GU10 (lampadine NON INCLUDE)



Code - 2 luci	Color
98512609	3 Gold
	4 Corten
	5 White
Code - 3 luci	6 Ardesia
	7 Grey
	98512709

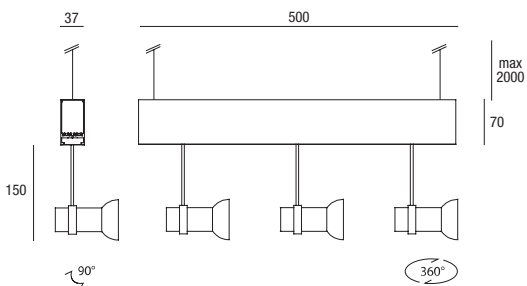
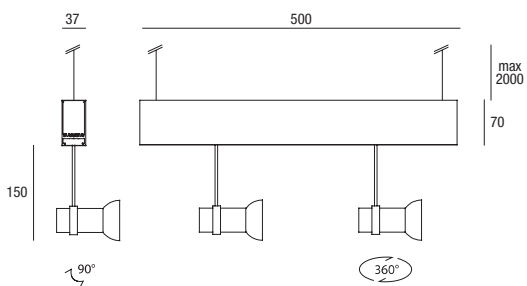



ACCESSORI OMICRON SOSPENSIONE MODULARE

UGR<19

UGR<19 in funzione dell'installazione.
Utilizzabile solo con schermo prismatico e profili con una linea Led.
Fornito già assemblato nel modulo.

UGR<19 depending on installation.
Use only with prismatic screen and profiles with 1 line Led.
Already assembled into the module.

Code cm10

9895



Tappo piatto
Flat dead end

Code

9851



Color

- 3 Gold
- 4 Corten
- 5 White
- 6 Ardesia
- 7 Grey
- 9 Black



Tappo curvo
Curved flat end

Code

9852



Color

- 3 Gold
- 4 Corten
- 5 White
- 6 Ardesia
- 7 Grey
- 9 Black



Kit congiunzione
Junction Kit

Code

9858



Kit alimentazione
Electricity supply Kit

Code

9857



Color

- 3 Gold
- 4 Corten
- 5 White
- 6 Ardesia
- 7 Grey
- 9 Black



Modulo a sospensione senza Led con copertura in metallo verniciato
Suspension module without Led, with painted metal cover

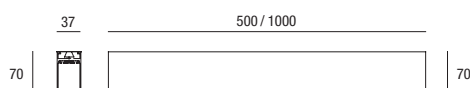

Code - 50 cm

98510091



Code - 100 cm

98510092



Color

- 3 Gold
- 4 Corten
- 5 White
- 6 Ardesia
- 7 Grey
- 9 Black



Curva 90° orizzontale senza Led con copertuna in metallo verniciato
90° Horizontal corner without Led, with painted metal cover

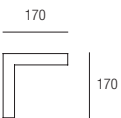

Code

98510011



Color

- 3 Gold
- 4 Corten
- 5 White
- 6 Ardesia
- 7 Grey
- 9 Black

Curva 90° orizzontale con Led
90° Horizontal corner with Led

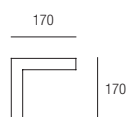

Watt/m	1 Linea Led Code	2 Linee Led Code	Color	Led
19,2	98510111	98510211	3 Gold	1 4000°K
20,2	98710111	98710211	4 Corten	6 3000°K
14,4	98810111	98810211	5 White	8 2700°K
			6 Ardesia	
			7 Grey	
			9 Black	

Code	Watt	Lumen 4000°K	Lumen 3000°K	Lumen 2700°K	Gr	Code	Watt	Lumen 4000°K	Lumen 3000°K	Lumen 2700°K	Gr
1 LINEA						2 LINEE					
98510111	5,7	474	462	447	370	98510211	10,6	849	847	820	384
98710111	5,8	888	832	776	370	98710211	11,6	1776	1664	1553	384
98810111	4,3	584	552	514	370	98810211	8	1070	1010	942	384

ACCESSORI PER SISTEMA MODULARE A SOSPENSIONE

Congiunzione a "T" senza Led con copertura in metallo verniciato
"T" junction without Led, with painted metal cover

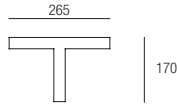

Code

Color

98510014



- 3 Gold
- 4 Corten
- 5 White
- 6 Ardesia
- 7 Grey
- 9 Black

Congiunzione a "T"
"T" junction

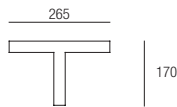

Watt/m

1 Linea Led

2 Linee Led

Color

Led

19,2
20,2
14,4

Code
98510114
98710114
98810114

Code
98510214
98710214
98810214

- 3 Gold
- 4 Corten
- 5 White
- 6 Ardesia
- 7 Grey
- 9 Black

1 4000°K
6 3000°K
8 2700°K



Code	Watt	Lumen	Lumen	Lumen	Gr	Code	Watt	Lumen	Lumen	Lumen	Gr
1 LINEA		4000°K	3000°K	2700°K		2 LINEE		4000°K	3000°K	2700°K	
98510114	7,2	593	578	560	514	98510214	14,4	1186	1156	1118	530
98710114	7,2	1112	1050	980	514	98710214	14,4	2224	2100	1960	530
98810114	5	682	642	600	514	98810214	10	1364	1284	1200	530

Congiunzione a "CROCE" senza Led con copertura in metallo verniciato
"CROSS" junction without Led, with painted metal cover

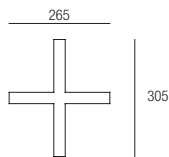

Code

Color

98510018



- 3 Gold
- 4 Corten
- 5 White
- 6 Ardesia
- 7 Grey
- 9 Black

Congiunzione a "CROCE"
"CROSS" junction

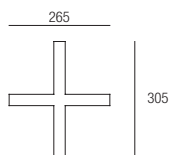

Watt/m

1 Linea Led

2 Linee Led

Color

Led

19,2
20,2
14,4

Code
98510118
98710118
98810118

Code
98510218
98710218
98810218

- 3 Gold
- 4 Corten
- 5 White
- 6 Ardesia
- 7 Grey
- 9 Black

1 4000°K
6 3000°K
8 2700°K



Code	Watt	Lumen	Lumen	Lumen	Gr	Code	Watt	Lumen	Lumen	Lumen	Gr
1 LINEA		4000°K	3000°K	2700°K		2 LINEE		4000°K	3000°K	2700°K	
98510118	9,6	790	770	745	710	98510218	19,2	1580	1540	1480	730
98710118	9,4	1445	1362	1270	710	98710218	18,4	2890	2724	2540	730
98810118	6,5	876	826	770	710	98810218	13	1752	1652	1540	730



Esecuzioni personalizzate effettuate con il profilo OMICRON per COOPERATIVA IL CERCHIO COLORATO ONLUS.

ALIMENTATORI inseribili nei moduli a sospensione
DRIVERS to insert into suspension modules

Code

1240	max 20W	24Vdc
1241	max 35W	24Vdc
1242	max 60W	24Vdc
1201	max 75W	24Vdc
1181	max 150W	24Vdc

CENTRALINE PER DIMMERAZIONE inseribili nei moduli a sospensione
DIMMABLE DRIVERS to insert into suspension modules

Code

1260	3x60W	DALI - 0-10V - PUSH (solo per luce Down)
1300	240W	PUSH - 0-10V - 1-10V
1303	240W	CASAMBI - PUSH
1304	240W	DALI - PUSH - 0-10V - 1-10V
1306	190W	PUSH
1308	190W	RF - PUSH+TELECOMANDO 4 zone
1309	190W	RF - PUSH+PULSANTE wireless
1311	2x120W	RF - PUSH (2CH) - APP TUYA - ALEXA - AMAZON ECHO

Poliambulatorio
Dott. G. Ferrarini

- Dott. Giuseppe Ferrarini
Medico Chirurgo - Odontoiatra
Dentista Specialistico
- Dott.ssa Laura Medoni
Medico Chirurgo - Odontoiatra
- Dott. Francesco Sassi
Odontoiatra
- Dott.ssa Elisabetta Cabassi
Odontoiatra
Specialista in Ortodonzia
- Dott.ssa Chiara Tronchi
Odontoiatra
- Prof. Andrea Broggi
Medico Chirurgo - Odontoiatra
Specialista in Chirurgia Maxillo-Facciale
- Dott. Paolo De Bernardi
Chirurgo Vascolare



Grafico composizione sistema
System composition

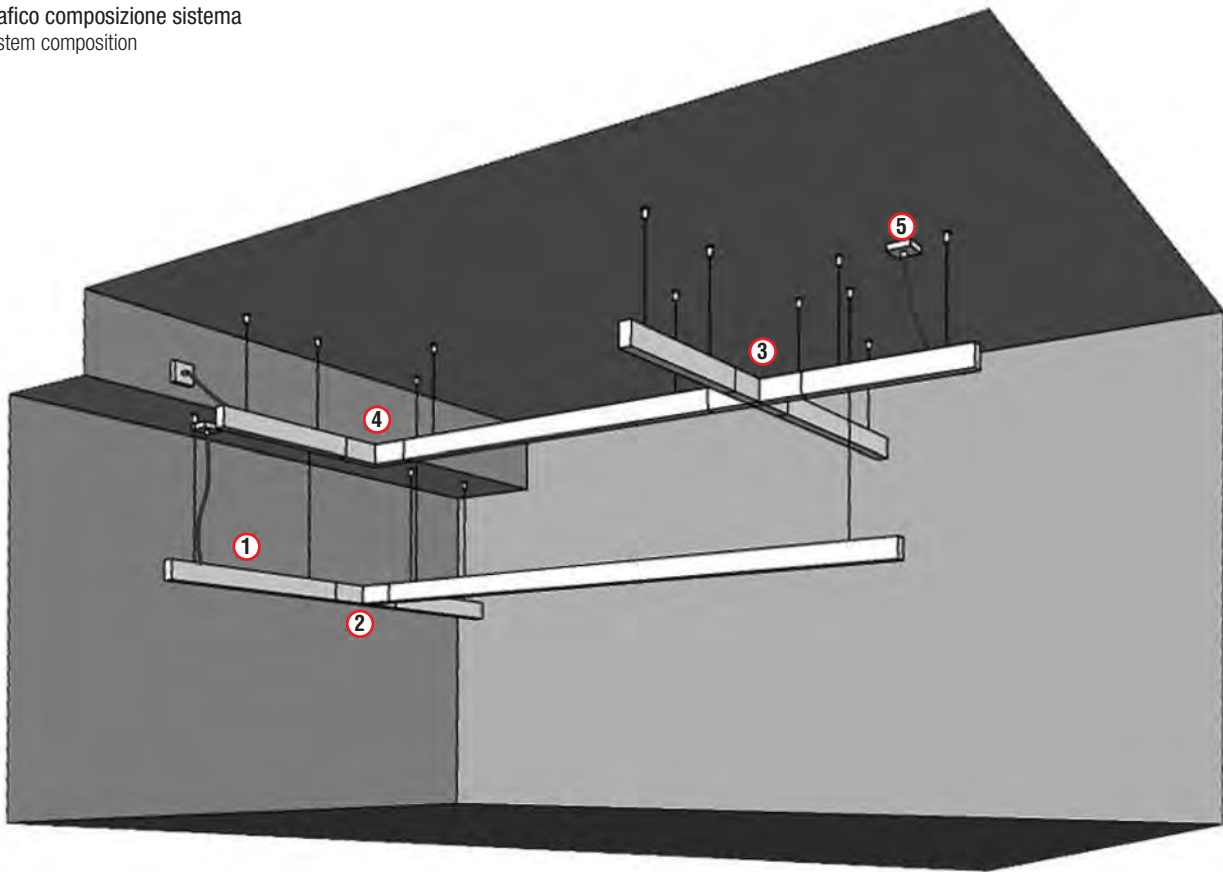

- ① Moduli a sospensione con sorgenti luminose
Suspension modules with light sources

- ② Congiunzione a "T" chiusa
Closed "T" junction

- ② Congiunzione a "T"
"T" junction

98510014

98510114 - 98510214

98710114 - 98710214

98810114 - 98710214

- ③ Congiunzione a "CROCE" chiusa
Closed "CROSS" junction

- ③ Congiunzione a "CROCE"
"CROSS" junction

- ④ Curva 90° orizzontale chiusa
90° horizontal corner closed

98510018

98510118 - 98510218

98710118 - 98710218

98810118 - 98810218

98510011

- ④ Curva 90° orizzontale
90° horizontal corner

- ⑤ Kit alimentazione
Electricity supply kit

98510111 - 98510211

98710111 - 98710211

98810111 - 98810211

9857

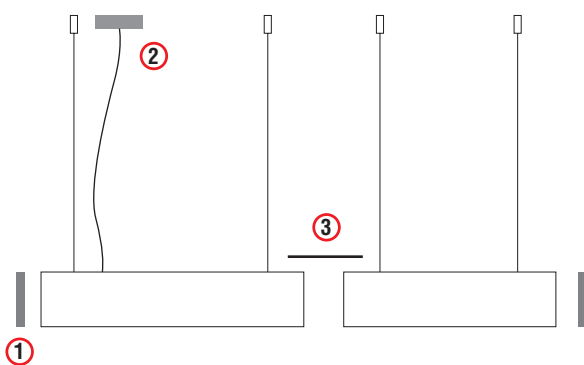

- ① **9851 - 9852**

Tappo piatto - Flat dead end

- ② **9857**

Kit Alimentazione - Electricity supply kit

- ③ **9858**

Kit congiunzione - Junction kit

HANGAR

Design Athena

Controcassa in alluminio da incasso per profili e moduli Led. Nella controcassa possono essere alloggiati, per tagli di luce retrocessa, i profili delle collezioni SIGMA e SIHON, i moduli con punti luce Led o i moduli con faretti. I profili e i moduli sono disponibili nelle finiture oro, bianco e nero.

Recessed aluminium profile for SIGMA and SIHON Led profiles, modules with Led lenses and spot lights. The collection is available in gold, white and black finishes.

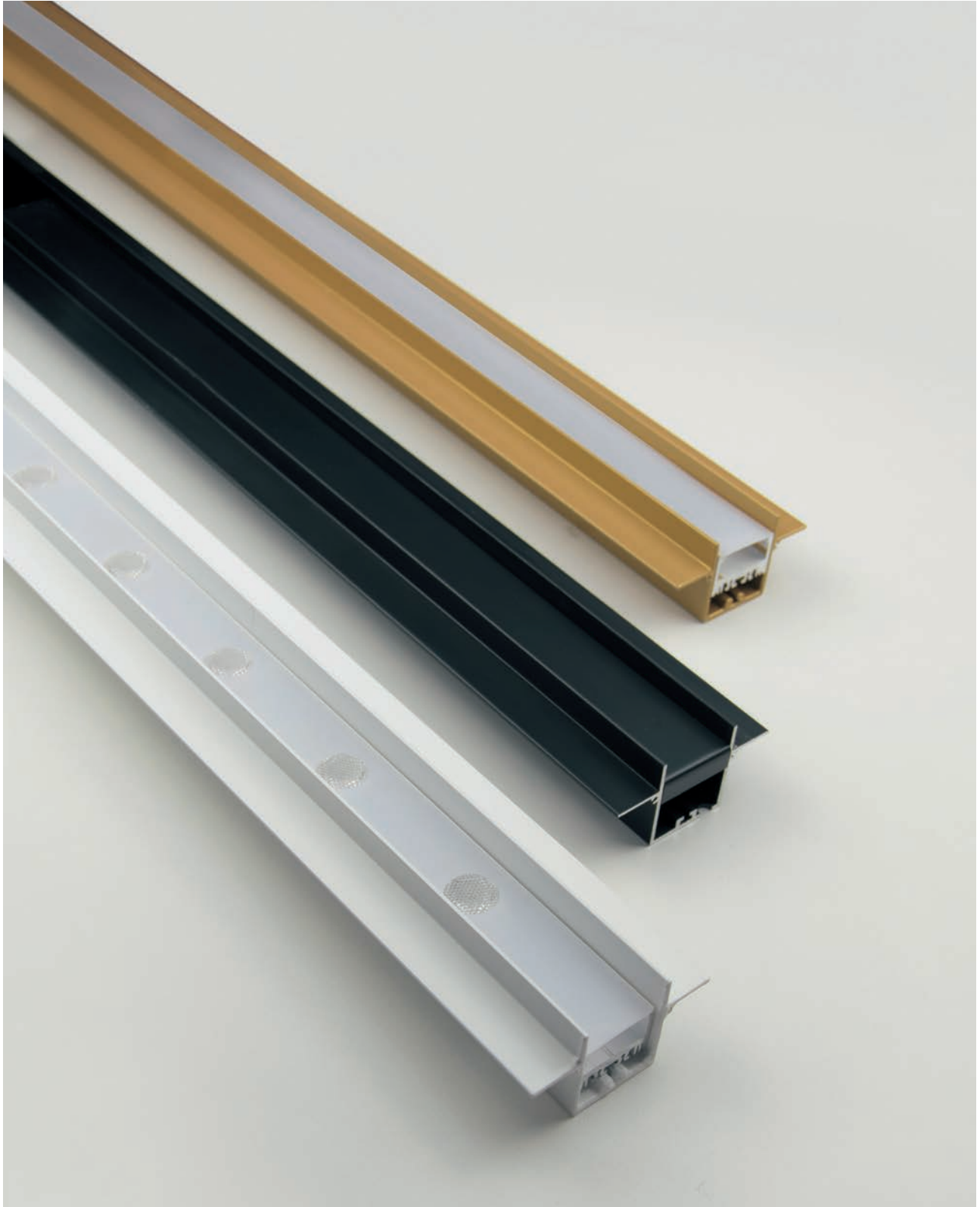

Il codice del prodotto è riferito a 10 cm di profilo. In fase d'ordine precisare la misura del profilo richiesta.
Code number refer to 10 cm profile. Ordering, specify the length of the profile request.

HANGAR



Controcassa in alluminio
Aluminium recessed profile

Code - 10 cm **Color**

- | | | | |
|-------------|----------|--|-------|
| 4399 | 3 | | Gold |
| | 5 | | White |
| | 9 | | Black |



Tappo
Dead-end

Code **Color**

- | | | | |
|-------------|----------|--|-------|
| 4352 | 3 | | Gold |
| | 5 | | White |
| | 9 | | Black |



Elemento di congiunzione meccanico lineare
Mechanical linear connector

Code

9653



Elemento di congiunzione meccanico per angolo 90° orizzontale
Mechanical connector for horizontal corner 90°

Code

9657



Curva orizzontale
Horizontal corner

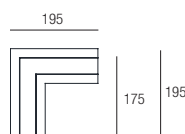

Code **Color**

- | | | | |
|-------------|----------|--|-------|
| 4350 | 3 | | Gold |
| | 5 | | White |
| | 9 | | Black |

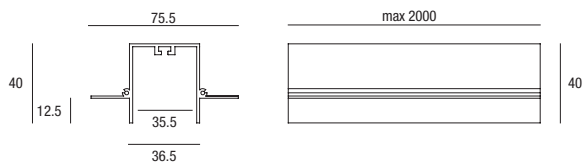

ACCESSORI HANGAR - SIGMA

SIGMA - Profilo alluminio verniciato con policarbonato PMMA satinato o prismatico completo di accessori per il fissaggio sulla controcassa Hangar 4399. Lunghezza massima cm 200.

SIGMA - Aluminum profile with PMMA and prismatic screen complete with accessories to insert into profile 4399. Max length cm 200.

SIGMA - Profilo senza Led. Includi 2 staffe di fissaggio.

SIGMA - Profile without Led. 2 ceiling kit included.



Code cm10	Color	No Led
90699	2 Aluminium	
	3 Gold	
	5 White	
	9 Black	

SIGMA - Profilo con Led. Includi 2 staffe di fissaggio.

SIGMA - Profile with Led. 2 ceiling kit included.



Watt/m	1 Linea Led Code - 10 cm	2 Linee Led Code - 10 cm	Color	Led
19,2	906119	906219	2 Aluminium	1 4000°K
20,2	906121	906221	3 Gold	6 3000°K
14,4	906124	906224	5 White	8 2700°K
			9 Black	



Code	Linee x W/mt	Led/mt	Lm/mt 4000°K	Lm/mt 3000°K	Lm/mt 2700°K	Code	Linee x W/mt	Led/mt	Lm/mt 4000°K	Lm/mt 3000°K	Lm/mt 2700°K
906119	1x19,2	240	1580	1540	1490	906219	2x19,2	480	3160	3080	2980
906121	1x20,2	224	3114	2937	2740	906221	2x20,2	448	6228	5874	5480
906124	1x14,4	140	1947	1836	1712	906224	2x14,4	280	3894	3672	3424

24 Vdc CRI90 E/F SDCM3 30.000h -20° +40° 14,4 5,1 cm - 19,2 2,5 cm - 20,2 3,57 cm

Curva 90° orizzontale con Led

90° Horizontal corner with Led



170



Watt/m	1 Linea Led Code	2 Linee Led Code	Color	Led
19,2	906210111	906210211	2 Aluminium	1 4000°K
20,2	906310111	906310211	3 Gold	6 3000°K
14,4	906410111	906410211	5 White	8 2700°K
			9 Black	

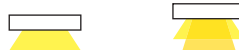

Code	Watt	Lumen 4000°K	Lumen 3000°K	Lumen 2700°K	Gr	Code	Watt	Lumen 4000°K	Lumen 3000°K	Lumen 2700°K	Gr
906210111	5,7	474	462	447	120	906210211	11,4	948	924	894	200
906310111	5,8	903	852	776	120	906310211	11,6	1776	1664	1552	200
906410111	4,3	584	550	514	120	906410211	8,6	1168	1100	1028	200

24Vdc Led CRI >90 CE IP 20



SCHERMI



1 Satinato



5 Prismatico

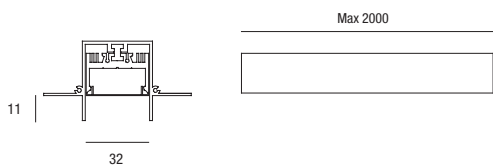

ACCESSORI



9896

Utilizzabile solo con schermo prismatico e profili con una linea Led.
Use only with prismatic screen and profiles with 1 line Led.

PROFILI TAGLIATI A MISURA PERSONALIZZATA COMPLETI DI LED

Il codice del prodotto è riferito a 10 cm di modulo completo di led. Per definire la lunghezza finale del profilo considerare la misura di taglio del Led.

Composizione Codice: modulo cm 170 bianco - 2 Led x 20,2 w/mt - ww = 906221 5,6 cm 170

TAILORED CUT PROFILES WITH LED

The code of the product is referred to 10 cm of it. To define the final length of the profile consider the cut measure of the Led).

Code Composition: profile cm 170 white - 2 Led x 20,2 w/mt - ww = 906221 5,6 cm 170

ACCESSORI HANGAR - SIHON

SIHON - Profilo alluminio verniciato con policarbonato PMMA satinato completo di accessori per il fissaggio sulla controcassa.
Lunghezza massima cm 200.

SIHON - Aluminum profile with PMMA screen complete with accessories to insert into profile 4399. Max length cm 200.

SIHON - Profilo senza Led. Includi 2 staffe di fissaggio.

SIHON- Profile without Led. 2 ceiling kit included.



Code - 10 cm	Color	No Led
93699	2 Aluminium	
	3 Gold	
	5 White	
	9 Black	

SIHON - Profilo con Led. Includi 2 staffe di fissaggio.

SIHON- Profile with Led. 2 ceiling kit included.



Watt/m	Code - 10 cm	Color	Led
19,2	93619	2 Aluminium	1 4000°K
20,2	93621	3 Gold	6 3000°K
14,4	93624	5 White	8 2700°K
		9 Black	



Code	W/mt	Led/mt	Lm/mt 4000°K	Lm/mt 3000°K	Lm/mt 2700°K
93619	19,2	240	1580	1540	1490
93621	20,2	224	3114	2937	2740
93624	14,4	140	1947	1836	1712

24 Vdc CRI90 SDCM3 30.000h -20° + 40° 14,4 5,1 cm - 19,2 2,5 cm - 20,2 3,57 cm

Curva 90° orizzontale con Led

90° Horizontal corner with Led



Watt/m	Code	Color	Led
19,2	9362111	2 Aluminium	1 4000°K
20,2	9363111	3 Gold	6 3000°K
14,4	9364111	5 White	8 2700°K
		9 Black	



Code	Watt	Lumen 4000°K	Lumen 3000°K	Lumen 2700°K	Gr
9362111	5,7	474	462	447	200
9363111	5,8	903	852	776	200
9364111	4,3	584	550	514	200

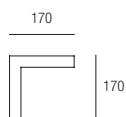

24Vdc Led CRI >90 IP 20



SCHERMI



1 Satinato
SL 28

6 Satinato
DL 14

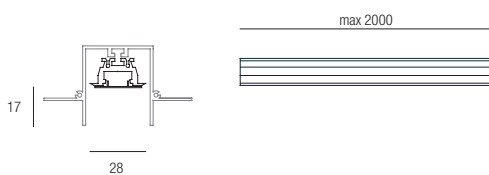

PROFILI TAGLIATI A MISURA PERSONALIZZATA COMPLETI DI LED

Il codice del prodotto è riferito a 10 cm di modulo completo di led. Per definire la lunghezza finale del profilo considerare la misura di taglio del Led.

Composizione Codice: modulo cm 170 bianco - x 20,2 w/mt - ww = 93621 5,6 cm 170

TAILORED CUT PROFILES WITH LED

The code of the product is referred to 10 cm of it. To define the final length of the profile consider the cut measure of the Led).

Code Composition: profile cm 170 white - x 20,2 w/mt - ww = 93621 5,6 cm 170

ACCESSORI HANGAR

Moduli composti da profilo in alluminio, Led con lente da alloggiare nella controcassa 4399.
Modules consisting of aluminium profile Led with lens. To insert into the recessed profile 4399.

HANGAR SL3 / SL6

Modulo 3 o 6 Led fissi - Module 3 or 6 fixed Leds.

9/18w tot 24Vdc 720/1440 lm tot

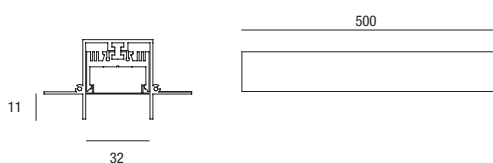

Code - 3 luci	Color	Led	Ottica
4321	3 Gold	1 4000°K	1 25°
	5 White	6 3000°K	6 60°
	9 Black		
Code - 6 luci			
4322	Color: 3-5 policarbonato satinato Color: 9 policarbonato nero		



ACCESSORI HANGAR

Moduli composti da profilo in alluminio e faretti. Da alloggiare nella controcassa 4399.
 Modules consisting of aluminium profile and spotlights. To insert into the recessed profile 4399.

HANGAR F02 / F03

Modulo 2 o 3 faretti GU10 orientabili - Module 2 or 3 GU10 adjustable spotlights.
 2/3 GU10 (lampadine NON INCLUDE)



Code - 2 luci **Color**

- | | | |
|----------------------|----------|-------|
| 4326 | 3 | Gold |
| | 5 | White |
| Code - 3 luci | 9 | Black |

4327

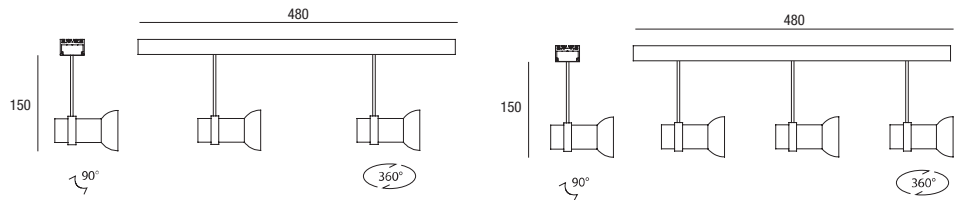

ACCESSORI DI COPERTURA

Modulo vuoto plafone chiuso
 Empty close ceiling module

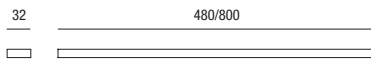

Code - 48 cm **Code - 80 cm** **Color**

- | | | | |
|--|---|----------|-------|
| 4391 | 4392 | 3 | Gold |
|  |  | 5 | White |
| 270 | 540 | 9 | Black |

ALIMENTATORI inseribili nel modello 4391 e 4392.
 DRIVERS to insert into 4391 and 4392.

Code		
1183	max 20W	24Vdc (non dimmerabile)
1201	max 75W	24Vdc
1181	max 150W	24Vdc

CENTRALINE PER DIMMERAZIONE inseribili nel modello 4391 e 4392.
 DIMMABLE DRIVERS to insert into 4391 and 4392.

Code		
1306	190W	PUSH
1308	190W	RF - PUSH+TELECOMANDO 4 zone wireless
1309	190W	RF - PUSH+PULSANTE wireless

Curva 90° orizzontale chiusa
 Closed 90° Horizontal corner

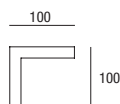

Code **Color**

- | | | |
|---|----------|-------|
| 4311 | 3 | Gold |
|  | 5 | White |
| 60 | 9 | Black |

SIGMA

Design Athena

Profilo in alluminio anodizzato completo di strip LED. Schermo in policarbonato, cavo alimentazione mm 2000.

Anodized aluminium profile completed with strip LED. Polycarbonate screen, wire length mm 2000.

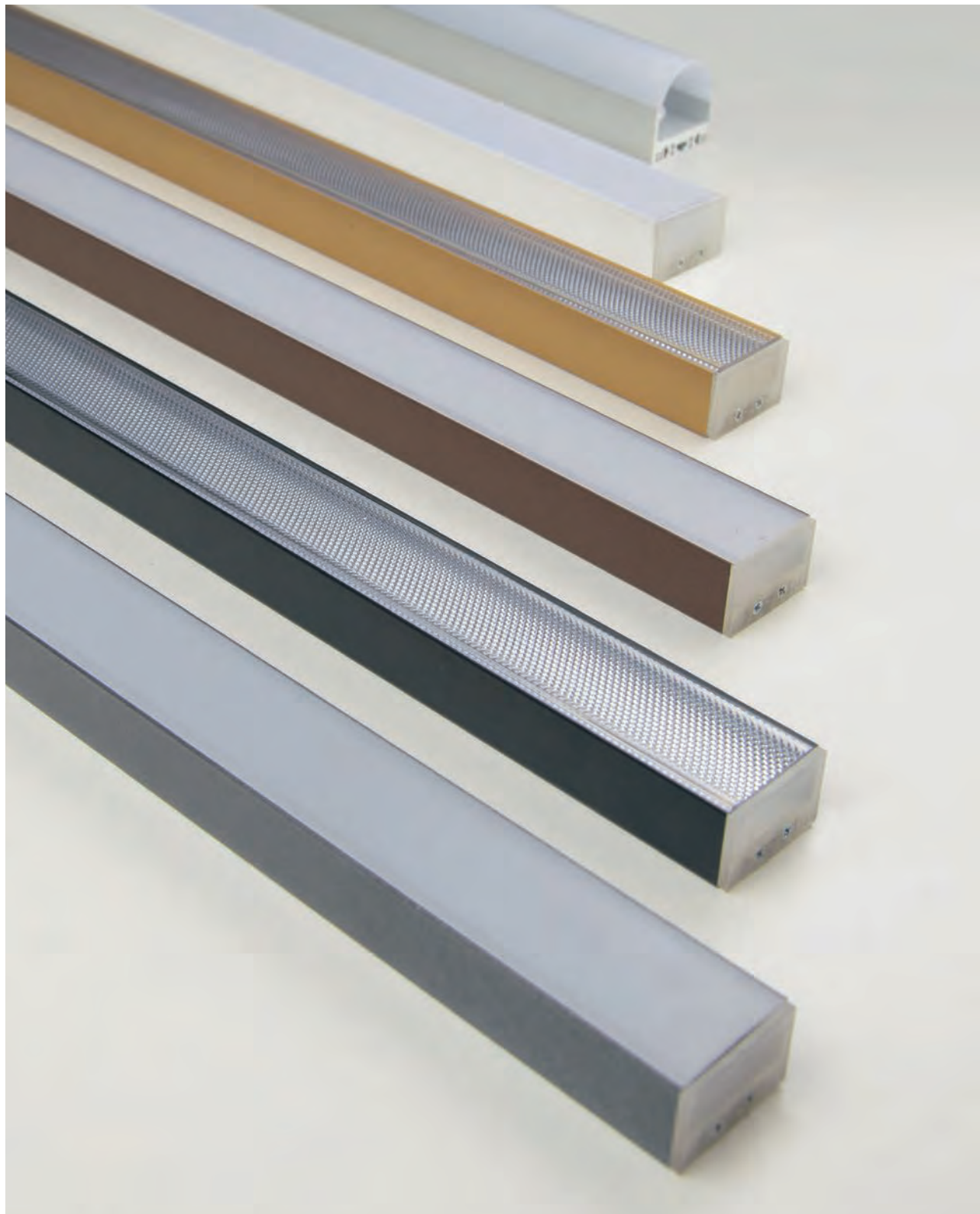

PROFILI TAGLIATI A MISURA PERSONALIZZATA COMPLETI DI LED

Il codice del prodotto è riferito a 10 cm di modulo completo di led. Per definire la lunghezza finale del profilo considerare la misura di taglio del led.

Composizione Codice: modulo cm 270 bianco - 19.2 WW - schermo piatto = 9019.5.6.1 cm 270

TAILORED CUT PROFILES WITH LED

The code of the product is referred to 10 cm of it. To define the final length of the profile consider the cut measure of the led.

Code Composition: profile cm 270 - White - 19.2 WW - flat screen = 9019.5.6.1 cm 270

SIGMA LED

Design Athena

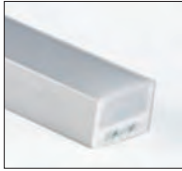

Watt/m	1 Linea Led Code - 10 cm	2 Linee Led Code - 10 cm	Color	Led
19,2	9019	90219	2 Aluminium	1 4000°K
20,2	9021	90221	3 Gold	6 3000°K
14,4	9024	90224	4 Corten	8 2700°K
			5 White	
			6 Ardesia	
			9 Black	

Code 1 LINEA	Linee x W/mt	Led/mt	Lm/mt 4000°K	Lm/mt 3000°K	Lm/mt 2700°K	Code 2 LINEE	Linee x W/mt	Led/mt	Lm/mt 4000°K	Lm/mt 3000°K	Lm/mt 2700°K
9019	1x19,2	240	1580	1540	1490	90219	2x19,2	480	3160	3080	2980
9021	1x20,2	224	3114	2937	2740	90221	2x20,2	448	6228	5874	5480
9024	1x14,4	140	1947	1836	1712	90224	2x14,4	280	3894	3672	3424

24 Vdc CRI90 E/F SDCM3 30.000h -20° +40° 14,4 5,1 cm - 19,2 2,5 cm - 20,2 3,57 cm

SCHERMI



1 Satinato 4 Curvo 5 Prismatico

ACCESSORI Elenco completo accessori pag 50



9896

Utilizzabile solo con schermo prismatico e profili con una linea Led.
Use only with prismatic screen and profiles with 1 line Led.

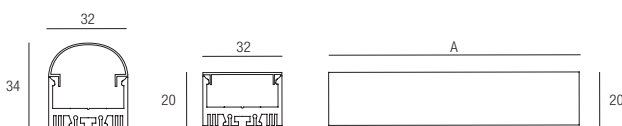

A: Color: 2 max cm 400 - 4-5-6-9 max cm 300 - 3 max cm 200

Led CRI >90 E/F CE IP 40

SIGMA

Design Athena

Profilo in alluminio estruso con schermo in policarbonato PMMA. Disponibile nelle finiture alluminio, oro, corten, bianco, ardesia e nero.

Anodized aluminium profile completed with polycarbonate PMMA. Available in aluminium, gold, corten, white dark grey and black finishes.



SCHERMI



1 Satinato



4 Curvo

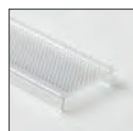

5 Prismatico

Code - 10 cm

9099

Color

- | | |
|---|-----------|
| 2 | Aluminium |
| 3 | Gold |
| 4 | Corten |
| 5 | White |
| 6 | Ardesia |
| 9 | Black |

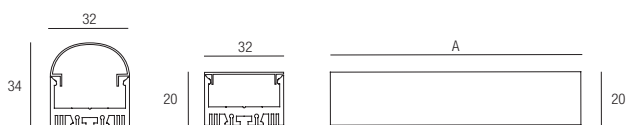

A: Color: **2** max cm 400 - **4-5-6-9** cm 300 - **3** max cm 200

Il codice del prodotto è riferito a 10 cm di profilo. In fase d'ordine precisare la misura del profilo richiesta.
Code number refer to 10 cm profile. Ordering, specify the length of the profile request.



ACCESSORI SIGMA

UGR<19

Utilizzabile solo con schermo prismatico e profili con una linea Led già assemblati.

Use only with prismatic screen and profiles with 1 line Led already assembled.

Code - 10 cm**9896**

Tappo per schermo curvo
Dead-end for curved screen

Code**Color****9047 con foro****9048 senza foro**

7



8

- | | |
|---|-----------|
| 2 | Aluminium |
| 3 | Gold |
| 4 | Corten |
| 5 | White |
| 6 | Ardesia |
| 9 | Black |



Tappo per schermo piatto
Dead-end for flat screen

Code**9051 senza foro****9052 con foro**

2



Angolo 90° verticale
90° vertical corner

**Code****Color****9049**

180

- | | |
|---|-----------|
| 2 | Aluminium |
| 3 | Gold |
| 4 | Corten |
| 5 | White |
| 6 | Ardesia |
| 9 | Black |



Angolo 90° orizzontale
90° horizontal corner

**Code****Color****9050**

180

- | | |
|---|-----------|
| 2 | Aluminium |
| 3 | Gold |
| 4 | Corten |
| 5 | White |
| 6 | Ardesia |
| 9 | Black |



Lavorazione taglio ad angolo orizzontale 45° dei profili
Horizontal 45° cutting of the profiles

Code**9660**

Elemento di congiunzione meccanico
Straight mechanical connector

Code**9653**

0,8



Elemento di congiunzione meccanico per angolo 90° orizzontale
Mechanical connector for horizontal corner 90°

Code**9657**

0,8



Elemento di congiunzione meccanico per angolo 90° verticale
 Mechanical connector for vertical corner 90°

Code _____

9658



Supporto per sospensione H 2000 mm
 Suspension kit H 2000 mm

Code _____

9654



Supporto parete/soffitto
 Wall/ceiling kit

Code _____

9656



Supporto parete/soffitto orientabile
 Wall/ceiling adjustable kit

Code _____

9659



Supporto parete/soffitto a calamita
 Magnet wall/ceiling support

Code _____

9661



Supporto parete/soffitto a sbalzo
 Wall/ceiling cantilever support

Code _____

9662



SIGMA 3 Profilo a incasso

Design Athena

Profilo in alluminio anodizzato con schermo in policarbonato completo di accessori per installazione a scomparsa in soffitti e pareti in cartongesso.

Anodized aluminium profile with polycarbonate screen and accessories for recessed mounting.

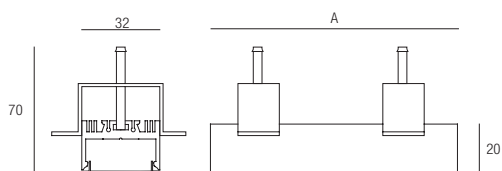

Code

90399

Color

2  Aluminium

A: Lunghezza massima cm 400 - per spedizioni max cm 300

Schema installazione
Mounting scheme

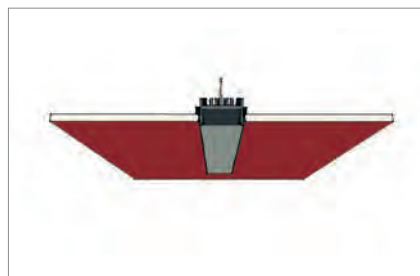
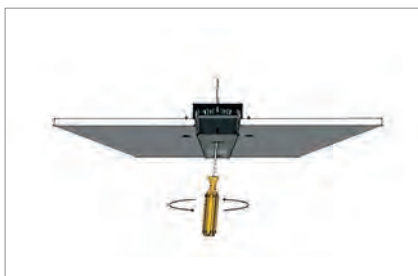
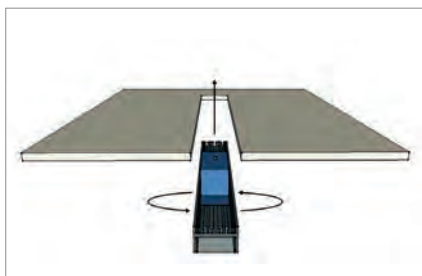

ACCESSORI SIGMA 3



Tappo
Dead-end

Code

9051 senza foro

9052 con foro



Angolo 90° verticale
90° vertical corner



Code

90349



Color

2 Aluminium



Angolo 90° orizzontale
90° horizontal corner



Code

90350



Color

2 Aluminium



Elemento di congiunzione meccanico
Straight mechanical connector

Code

9653



Elemento di congiunzione meccanico per angolo 90° orizzontale
Mechanical connector for horizontal corner 90°

Code

9657



Elemento di congiunzione meccanico per angolo 90° verticale
Mechanical connector for vertical corner 90°

Code

9658



Lavorazione taglio ad angolo orizzontale 45° dei profili
Horizontal 45° cutting of the profiles

Code

9660

TRIAX

Design Athena

Profilo in alluminio grezzo da incasso ottimizzato per la massima dissipazione termica. Schermi in policarbonato PMMA disponibili in due versioni. Tappi, alimentatori ed accessori da ordinare separatamente.

Raw aluminium profile optimized for maximum heat dissipation. Polycarbonate PMMA screens available in two versions. Caps, power supplies and accessories to be ordered separately.

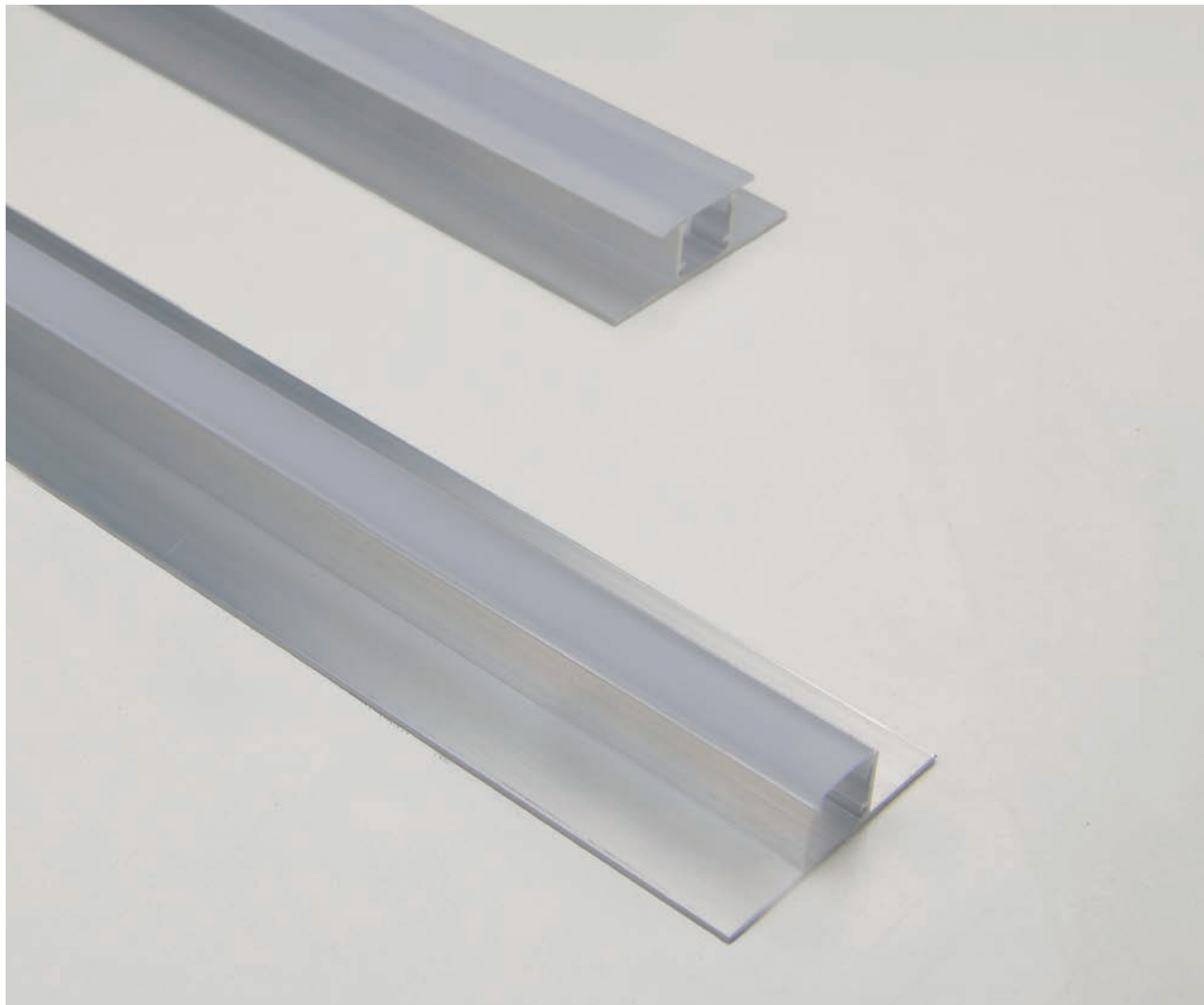

SCHERMI



1 Satinato
SL 28



6 Satinato
DL 14

Code - 10 cm

Color

4499

2  Raw Aluminium



A: max cm 400

Il codice del prodotto è riferito a 10 cm di profilo. In fase d'ordine precisare la misura del profilo richiesto.
Code number refer to 10 cm of the profile. Ordering, specify the length of the profile request.

ACCESSORI TRIAX



Tappo
Dead end

Code

4451



Lavorazione taglio ad angolo orizzontale 45° dei profili
Horizontal 45° cutting of the profiles

Code

9660

Schema installazione
Mounting scheme



DELTA

Design Athena

Profilo in alluminio anodizzato completo di strip LED. Schermo in policarbonato PMMA, cavo alimentazione mm 2000.

Anodized aluminium profile completed with strip LED and polycarbonate PMMA screen. Wire length mm 2000.

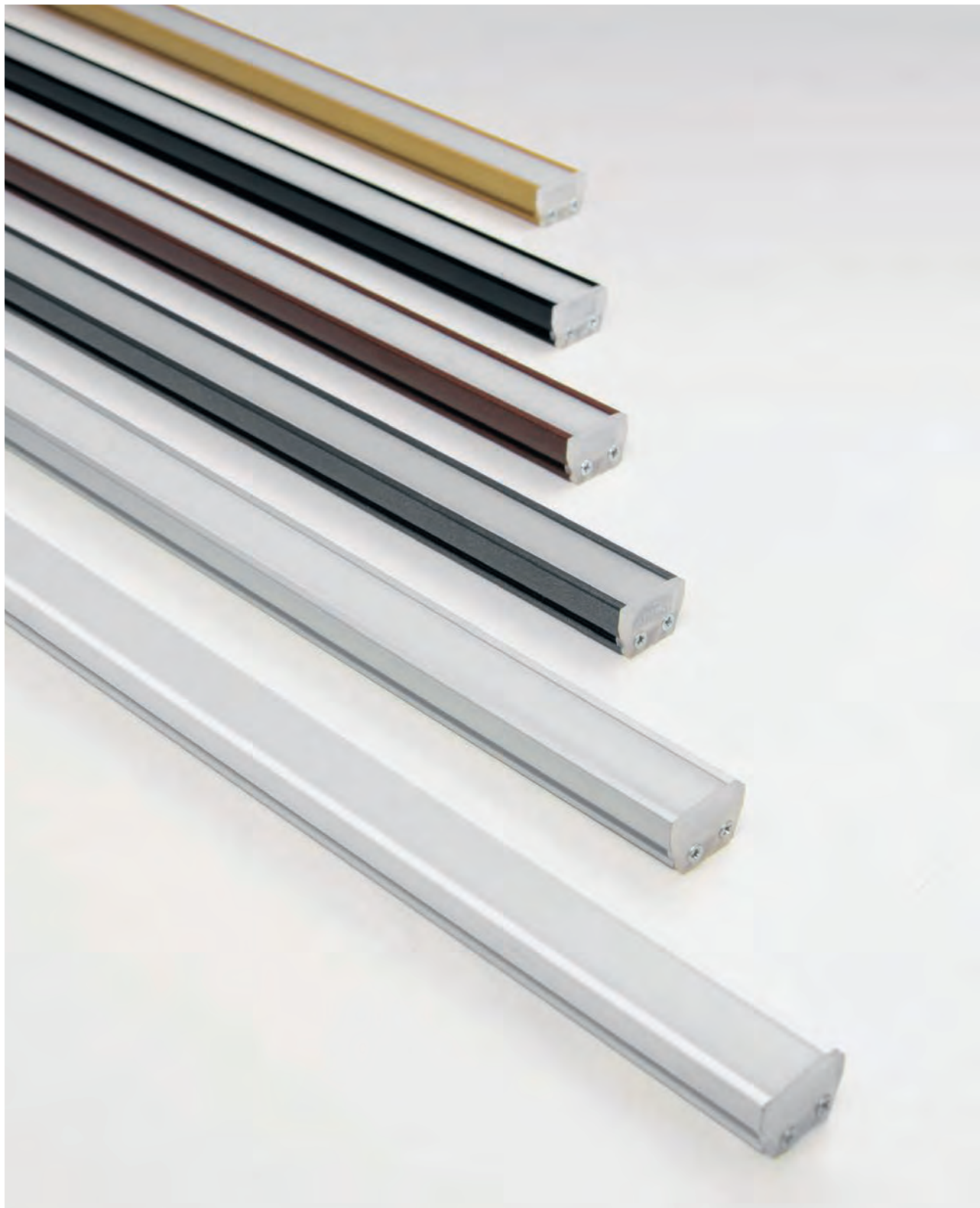

PROFILI TAGLIATI A MISURA PERSONALIZZATA COMPLETI DI LED

Il codice del prodotto è riferito a 10 cm di modulo completo di led. Per definire la lunghezza finale del profilo considerare la misura di taglio del Led.

Composizione Codice: modulo cm 270 bianco - 19.2 WW - schermo sat = 9619.5.6.1 cm 270

TAILORED CUT PROFILES WITH LED

The code of the product is referred to 10 cm of it. To define the final length of the profile consider the cut measure of the led.

Code Composition: profile cm 270 - all - 19.2 WW - sat screen = 9619.2.6.1 cm 270

DELTA LED

Design Athena

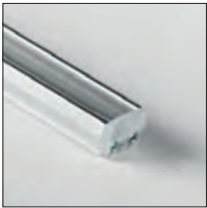

Watt/m	Code - 10 cm	Color	Led
19,2	9619	2 Aluminum	1 4000°K
20,2	9621	3 Gold	6 3000°K
14,4	9624	4 Corten	8 2700°K
		5 White	
		6 Ardesia	
		9 Black	

Code	W/mt	Led/mt	Lm/mt 4000°K	Lm/mt 3000°K	Lm/mt 2700°K
9619	19,2	240	1580	1540	1490
9621	20,2	224	3114	2937	2740
9624	14,4	140	1947	1836	1712

24 Vdc CRI90 **E/F** SDCM3 ⌚ 30.000h 🌡️ -20° + 40° ✂️ 14,4 5,1 cm - 19,2 2,5 cm - 20,2 3,57 cm ✂️

SCHERMI

ACCESSORI Elenco completo pag 60

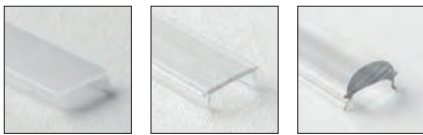

1 Satinato 2 Trasparente 3 Lente 40°/Trasp.

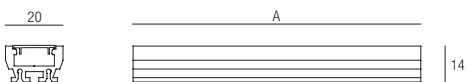

A: Color 2 max cm 400 - 4-5-6-9 max cm 300 - 3 max cm 200

Led CRI >90 **E/F** CE IP 40 🏠

DELTA LED TOUCH

Delta LED con interruttore dimmerabile touch - Potenza massima 60W.

Delta LED with dimmable touch switch (max 60W).



Watt/m	Code - 10 cm	Color	Led
19,2	96819	2 Aluminum	1 4000°K
20,2	96821	3 Gold	6 3000°K
14,4	96824	4 Corten	8 2700°K



5 White
6 Ardesia
9 Black

Code	W/mt	Led/mt	Lm/mt 4000°K	Lm/mt 3000°K	Lm/mt 2700°K
96819	19,2	240	1580	1540	1490
96821	20,2	224	3114	2937	2740
96824	14,4	140	1947	1836	1712

24 Vdc CRI80-90 SDCM3 30.000h -20°+40° 14,4 5,1 cm 19,2 2,5 cm 20,2 3,57 cm

DELTA LED MOVE

Delta LED con sensore di presenza (rilevazione max 3 mt. - 120° - max 70W).

Delta LED with presence detector (detection max 3 mt. - 120° - max 70W).



Watt/m	Code - 10 cm	Color	Led
9,6	96710	2 Aluminum	1 4000°K
20,2	96721	3 Gold	6 3000°K
14,4	96724	4 Corten	8 2700°K



5 White
6 Ardesia
9 Black

Code	W/mt	Led/mt	Lm/mt 4000°K	Lm/mt 3000°K	Lm/mt 2700°K
96710	9,6	120	887	837	
96721	20,2	224	3114	2937	2740
96724	14,4	140	1947	1836	1712

24 Vdc CRI80-90 SDCM3 30.000h -20°+40° 9,6 5 cm 14,4 5,1 cm 20,2 3,57 cm

DELTA TOUCH

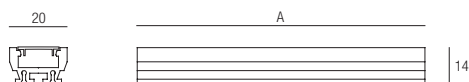

ACCESSORI Elenco completo pag 60

DELTA MOVE

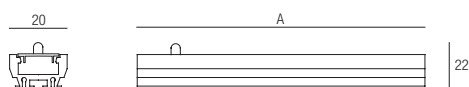

A: Color 2 max cm 400 - 4-5-6-9 max cm 300 - 3 max cm 200

Led CRI 80-90 IP 40



DELTA

Design Athena

Profilo in alluminio anodizzato con schermo in policarbonato PMMA.

Anodized aluminium profile complete with polycarbonate screen PMMA.



SCHERMI



1 Satinato 2 Trasparente 3 Lente 40/ trasp.

Code - cm 10

9699

Color

- | | |
|---|----------|
| 2 | Aluminum |
| 3 | Gold |
| 4 | Corten |
| 5 | White |
| 6 | Ardesia |
| 9 | Black |

ACCESSORI



Tappo
Dead-end

Code

9651 senza foro

9652 con foro



Angolo 90° verticale
90° vertical corner

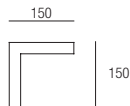

Code

9649



Color

- | | |
|---|----------|
| 2 | Aluminum |
| 3 | Gold |
| 4 | Corten |
| 5 | White |
| 6 | Ardesia |
| 9 | Black |

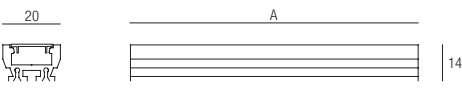

A: Color 2 max cm 400 - 4-5-6-9 max cm 300 - 3 max cm 200

Il codice del prodotto è riferito a 10 cm di profilo. In fase d'ordine precisare la misura del profilo richiesta.
Code number refer to 10 cm profile. Ordering, specify the length of the profile request.

ACCESSORI DELTA



Angolo 90° orizzontale
90° horizontal corner

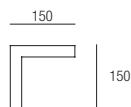

Code

Color

9650



- 2 Aluminum
- 3 Gold
- 4 Corten
- 5 White
- 6 Ardesia
- 9 Black



Lavorazione taglio ad angolo orizzontale 45° dei profili
Horizontal 45° cutting of the profiles

Code

9660



Elemento di congiunzione meccanico
Straight mechanical connector

Code

9653



Elemento di congiunzione meccanico per angolo 90° orizzontale
Mechanical connector for horizontal corner 90°

Code

9657



Elemento di congiunzione meccanico per angolo 90° verticale
Mechanical connector for vertical corner 90°

Code

9658



Supporto per sospensione H 2000 mm
Suspension kit H 2000 mm

Code

9654



Supporto parete/soffitto orientabile
Wall/ceiling adjustable kit

Code

9655



Supporto parete/soffitto
Wall/ceiling kit

Code

9656



Supporto a magnete
Magnet support

Code

9661



Supporto parete/soffitto a sbalzo
Wall/ceiling cantilever support

Code

9662



TAU

Design Athena

Profilo in alluminio anodizzato angolare completo di strip LED. Schermo in policarbonato PMMA, cavo alimentazione mm 2000.

Anodized aluminium profile complete with strip LED. Polycarbonate screen PMMA, wire length mm 2000.

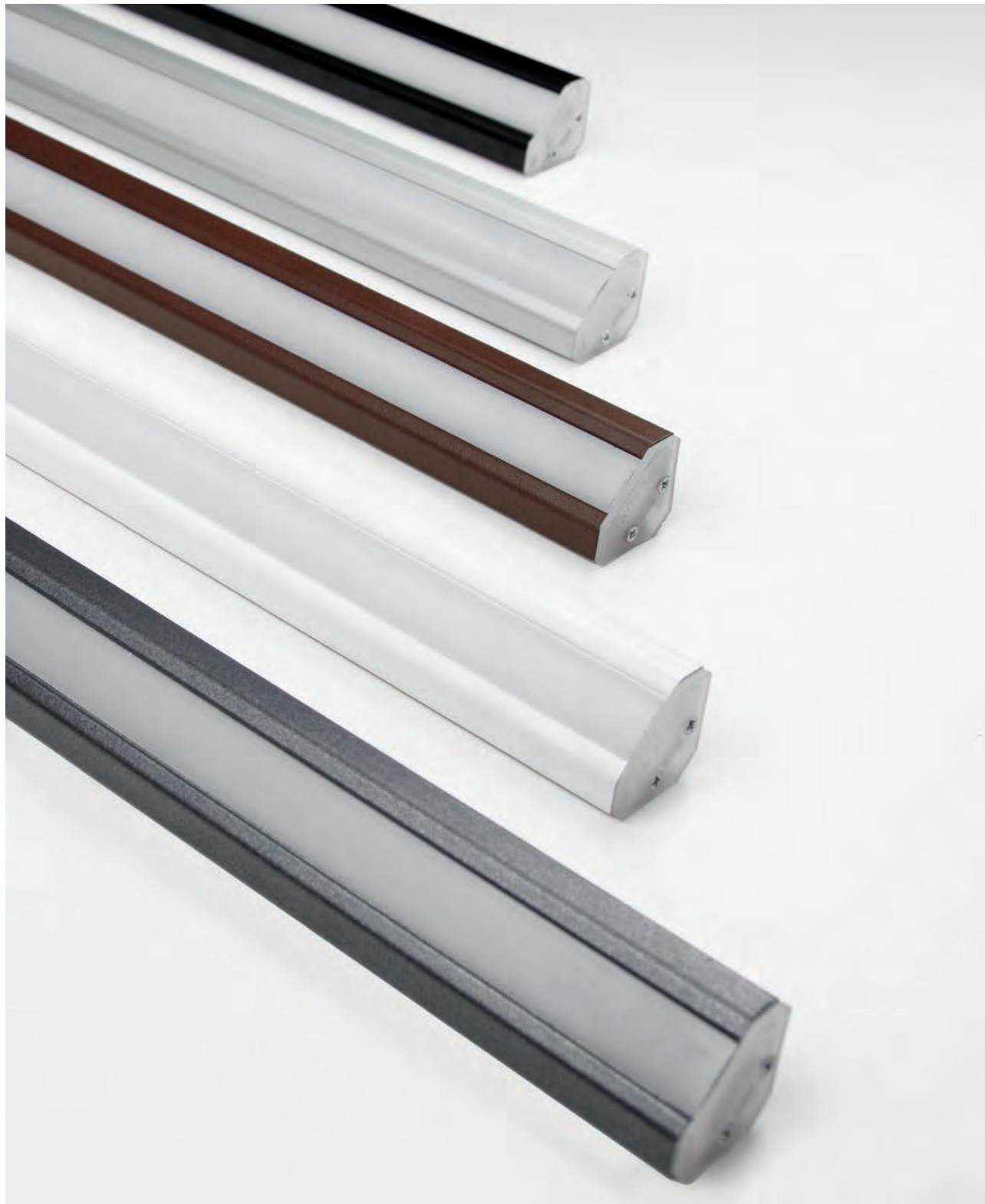

PROFILI TAGLIATI A MISURA PERSONALIZZATA COMPLETI DI LED

Il codice del prodotto è riferito a 10 cm di modulo completo di led. Per definire la lunghezza finale del profilo considerare la misura di taglio del led.

Composizione Codice: modulo cm 270 bianco - 19.2 WW - schermo sat = 9119.5.6.1 cm 270

TAILORED CUT PROFILES WITH LED

The code of the product is referred to 10 cm of it. To define the final length of the profile consider the cut measure of the led.

Code Composition: profile cm 270 - all - 19.2 WW - sat screen = 9119.2.6.1 cm 270

TAU LED

Design Athena



Watt/m	Code - 10 cm	Color	Led
19,2	9119	2 Aluminum	1 4000°K
20,2	9121	4 Corten	6 3000°K
14,4	9124	5 White	8 2700°K
		6 Ardesia	
		9 Black	



Code	W/mt	Led/mt	Lm/mt 4000°K	Lm/mt 3000°K	Lm/mt 2700°K
9119	19,2	240	1580	1540	1490
9121	20,2	224	3114	2937	2740
9124	14,4	140	1947	1836	1712

24 Vdc CRI90 SDCM3 30.000h -20° +40° 14,4 5,1 cm - 19,2 2,5 cm - 20,2 3,57 cm

SCHERMI

ACCESSORI Elenco completo pag 67

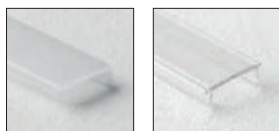

1 Satinato 2 Trasparente

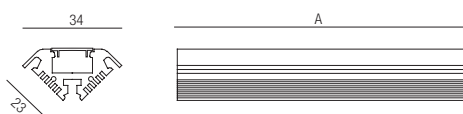

A: Color: 2 max cm 400 - 4-5-6-9 max cm 300

Led CRI >90 CE IP 40

TAU LED TOUCH

Tau LED con interruttore dimmerabile touch - Potenza massima 60W.
Tau LED with dimmable touch switch (max 60W).



Watt/m	Code - 10 cm	Color	Led
19,2	91819	2 Aluminum	1 4000°K
20,2	91821	4 Corten	6 3000°K
14,4	91824	5 White	8 2700°K
		6 Ardesia	
		9 Black	

Code	W/mt	Led/mt	Lm/mt 4000°K	Lm/mt 3000°K	Lm/mt 2700°K
91819	19,2	240	1580	1540	1490
91821	20,2	224	3114	2937	2740
91824	14,4	140	1947	1836	1712

24 Vdc CRI80-90 SDCM3 30.000h -20° +40° 14,4 5,1 cm 19,2 2,5 cm 20,2 3,57 cm

TAU LED MOVE

Tau LED con sensore di presenza (rilevazione max 3 mt. - 120° - max 70W).
Tau LED with presence detector (detection max 3 mt. - 120° - max 70W).



Watt/m	Code - 10 cm	Color	Led
9,6	91710	2 Aluminum	1 4000°K
20,2	91721	4 Corten	6 3000°K
14,4	91724	5 White	8 2700°K
		6 Ardesia	
		9 Black	

Code	W/mt	Led/mt	Lm/mt 4000°K	Lm/mt 3000°K	Lm/mt 2700°K
91710	9,6	120	887	837	
91721	20,2	224	3114	2937	2740
91724	14,4	140	1947	1836	1712

24 Vdc CRI80-90 SDCM3 30.000h -20° +40° 9,6 5cm 14,4 5,1 cm 20,2 3,57cm

TAU LED TOUCH

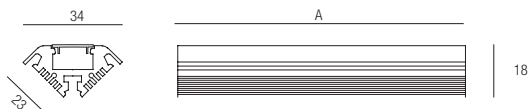

TAU LED MOVE

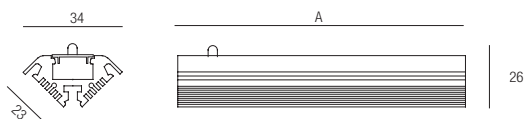

A: Color 2 max cm 400 - 4-5-6-9 max cm 300

Led CRI 80-90 IP 40



TAU

Design Athena

Profilo angolare in alluminio anodizzato con schermo in policarbonato.
Anodized aluminium profile with polycarbonate screen.



SCHERMI

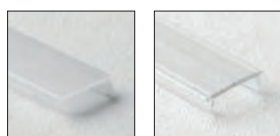





1 Satinato

2 Trasparente

Code

9199

Color

- 2  Aluminum
- 4  Corten
- 5  White
- 6  Ardesia
- 9  Black

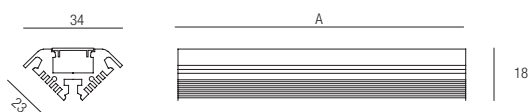

A = Color **2** max cm 400 - **4-5-6-9** max cm 300

Il codice del prodotto è riferito a 10 cm di profilo. In fase d'ordine precisare la misura del profilo richiesta.
Code number refer to 10 cm profile. Ordering, specify the length of the profile request.

ACCESSORI TAU



Tappo
Dead-end

Code _____

9151 senza foro

9152 con foro



Elemento di congiunzione meccanico
Straight mechanical connector

Code _____

9653



Supporto parete/soffitto
Wall/ceiling kit

Code _____

9656



Lavorazione taglio ad angolo orizzontale 45° dei profili
Horizontal 45° cutting of the profiles

Code _____

9660



Supporto parete/soffitto a sbalzo
Wall/ceiling cantilever support

Code _____

9662



SIHON

Design Athena

Profilo in alluminio anodizzato completo di strip led. Installazione a parete, soffitto e ad incasso.
Schermo in policarbonato satinato: a richiesta schermo trasparente. Cavo di alimentazione rosso/nero mm500.

Anodized aluminium profile complete with strip Led. Wall, ceiling and recessed installation. Satined polycarbonate screen: clear screen on demand. Red/black mm500 cable.

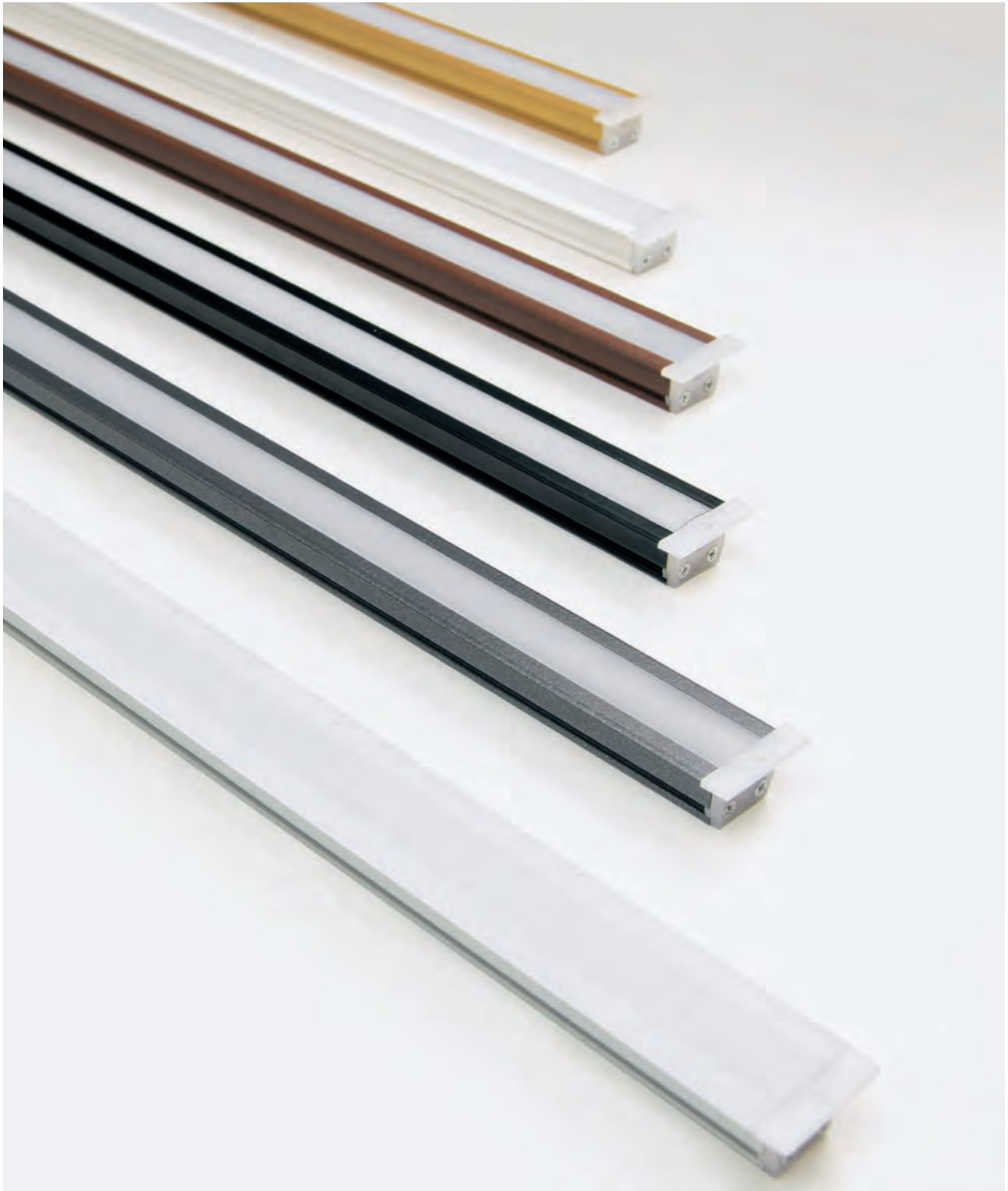

PROFILI TAGLIATI A MISURA PERSONALIZZATA COMPLETI DI LED

Il codice del prodotto è riferito a 10 cm di modulo completo di led. Per definire la lunghezza finale del profilo considerare la misura di taglio del led.

Composizione Codice: modulo cm 270 bianco - 19.2 NW - schermo sat = 9319.5.1.1 cm 270

TAILORED CUT PROFILES WITH LED

The code of the product is referred to 10 cm of it. To define the final length of the profile consider the cut measure of the led).

Code Composition: profile cm 270 - all - 19.2 WW - sat screen = 9319.2.6.1 cm 270

SIHON LED

Design Athena

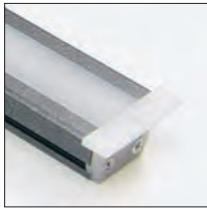

Watt/m	Code - 10 cm	Color	Led
19,2	9319	2 Aluminum	1 4000°K
20,2	9321	3 Gold	6 3000°K
14,4	9324	4 Corten	8 2700°K
		5 White	
		6 Ardesia	
		9 Black	

Code	W/mt	Led/mt	Lm/mt 4000°K	Lm/mt 3000°K	Lm/mt 2700°K
9319	19,2	240	1580	1540	1490
9321	20,2	224	3114	2937	2740
9324	14,4	140	1947	1836	1712

24 Vdc CRI90 SDCM3 30.000h -20° + 40° 14,4 5,1 cm - 19,2 2,5 cm - 20,2 3,57 cm

SCHERMI

ACCESSORI Elenco completo pag 73



1 Satinato
SL 28

6 Satinato
DL 14

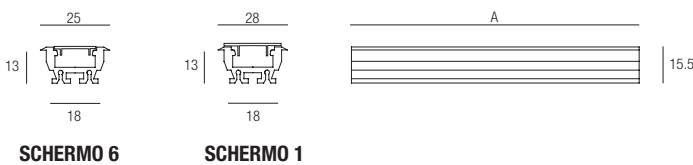

A = Color: 2 max cm 400 - 4-5-6-9 max cm 300 - 3 max cm 200

Led CRI > 90 IP 40

SIHON LED TOUCH

Sihon LED con interruttore dimmerabile touch - Potenza massima 60W.
Sihon LED with dimmable touch switch (max 60W).



Watt/m	Code - 10 cm	Color	Led
19,2	93819	2 Aluminum	1 4000°K
20,2	93821	3 Gold	6 3000°K
14,4	93824	4 Corten	8 2700°K



5 White
6 Ardesia
9 Black

Code	W/mt	Led/mt	Lm/mt 4000°K	Lm/mt 3000°K	Lm/mt 2700°K
93819	19,2	240	1580	1540	1490
93821	20,2	224	3114	2937	2740
93824	14,4	140	1947	1836	1712

24 Vdc CRI80-90 **E/F** SDCM3 30.000h -20° +40° 14,4 5,1 cm 19,2 2,5 cm 20,2 3,57 cm

SIHON LED MOVE

Sihon LED con sensore di presenza (rilevazione max 3 mt. - 120° - max 70W).
Sihon LED with presence detector (detection max 3 mt. - 120° - max 70W).



Watt/m	Code - 10 cm	Color	Led
9,6	93710	2 Aluminum	1 4000°K
14,4	93724	3 Gold	6 3000°K
20,2	93721	4 Corten	8 2700°K



5 White
6 Ardesia
9 Black

Code	W/mt	Led/mt	Lm/mt 4000°K	Lm/mt 3000°K	Lm/mt 2700°K
93710	9,6	120	887	837	
93721	20,2	224	3114	2937	2740
93724	14,4	140	1947	1836	1712

24 Vdc CRI80-90 **E/F** SDCM3 30.000h -20° +40° 9,6 5cm 14,4 5,1cm 20,2 3,57cm

SIHON LED TOUCH

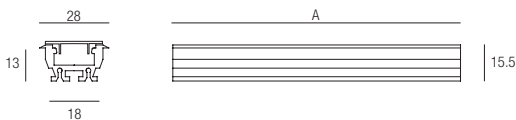

ACCESSORI Dettagli pag 73

SIHON LED MOVE

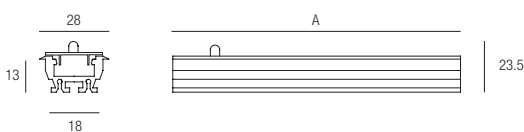

A = Color **2** max cm 400 - **4-5-6-9** max cm 300 - **3** max cm 200

Led CRI 80-90 **E/F** **CE** IP 40



SIHON

Design Athena

Profilo in alluminio anodizzato con schermo in policarbonato satinato, installazione anche ad incasso.
Anodized aluminium recessed profile complete with satined polycarbonate screen.



SCHERMI



1 Satinato
SL 28







6 Satinato
DL 14

Code

9399

Color

- 2**  Aluminum
- 3**  Gold
- 4**  Corten
- 5**  White
- 6**  Ardesia
- 9**  Black

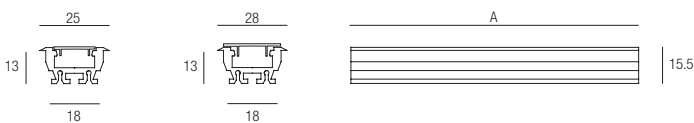

SCHERMO 6

SCHERMO 1

A = Color: **2** max cm 400 - **4-5-6-9** max cm 300 - **3** max cm 200

Il codice del prodotto è riferito a 10 cm di profilo. In fase d'ordine precisare la misura del profilo richiesta.
Code number refer to 10 cm profile. Ordering, specify the length of the profile request.

ACCESSORI SIHON



Tappo
Dead-end

Code

9352



Angolo 90° verticale
90° vertical corner

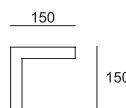

Code

9349



Color

- 2 Aluminum
- 3 Gold
- 4 Corten
- 5 White
- 6 Ardesia
- 9 Black



Angolo 90° orizzontale
90° horizontal corner

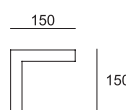

Code

9350



Color

- 2 Aluminum
- 3 Gold
- 4 Corten
- 5 White
- 6 Ardesia
- 9 Black



Lavorazione taglio ad angolo orizzontale 45° dei profili
Horizontal 45° cutting of the profiles

Code

9660



Elemento di congiunzione meccanico
Straight mechanical connector

Code

9653



Elemento di congiunzione meccanico per angolo 90° orizzontale
Mechanical connector for horizontal corner 90°

Code

9657



Elemento di congiunzione meccanico per angolo 90° verticale
Mechanical connector for vertical corner 90°

Code

9658



Supporto per sospensione H 2000 mm
Suspension kit H 2000 mm

Code

9654



Supporto parete/soffitto
Wall/ceiling kit

Code

9656



Supporto parete/soffitto a sbalzo
Wall/ceiling cantilever support

Code

9662



ACCESSORI SIHON



Supporto parete/soffitto orientabile
Wall/ceiling kit

Code

9655

Molla per incasso controsoffitto e controcassa
Foro incasso larghezza 19 mm - altezza 29 mm:
Posizionare inizio-fine +1 ogni 50 cm.
Spring for recessed ceiling.
Recessed hole width 19 mm - height 29 mm.
Place: beginning, end and 1 every 50 cm

Code

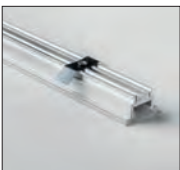
9353

Molla a pressione
Foro incasso larghezza 20 mm - Altezza 14 mm
Posizionare inizio-fine +1 ogni 50 cm.
Spring for recessed ceiling.
Recessed hole width 20 mm - Height 14 mm.
Place: beginning, end and 1 every 50 cm

Code

9354

Supporto a calamita.
Foro incasso larghezza 21 mm - Altezza 16 mm
Posizionare inizio-fine +1 ogni 50 cm.
Magnet support.
Recessed hole width 21 mm - Height 16 mm
Place: beginning, end and 1 every 50 cm

Code

9661

ACCESSORI SIHON PER INCASSO IN MURATURE E LATERIZI



Controcassa curva orizzontale per incasso murature e laterizio.
Horizontal corner casing for brickwork.

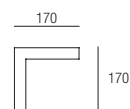

Code

930549



Controcassa curva verticale per incasso murature e laterizio.
Vertical corner casing for brickwork.

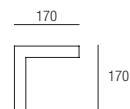

Code

930550



Controcassa per incasso murature e laterizio.
Casing for brickwork.

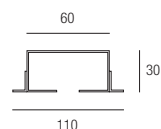

Code - cm 10

930599



Utilizzare con molle 9353.
Use with 9353 springs.

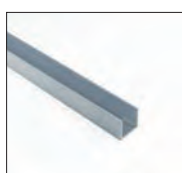

Controcassa per incasso murature e laterizio.
Lunghezza max cm 300.
Casing for brickwork.
Max length cm 300.

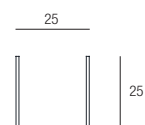

Code - cm 10

930595



Utilizzare con molle 9354.
Use with 9354 springs.

SLASH

Design Athena

Sistema modulare e componibile composto da binari in alluminio completo di strip Led, schermi in pmma, disponibile nelle finiture corten, bianco, ardesia e nero, con la possibilità di alloggiare o meno l'alimentatore al suo interno. Tappi, alimentatori e accessori da ordinare separatamente. Schermo in policarbonato satinato. Possibilità di creare varie figure e giochi di luce sovrapponendo i profili con l'accessorio 4054.

Modular system composed of aluminum profiles completed with strip Led, pmma screens, available in corten, white, dark grey and black, with the possibility of housing or not the power supply inside. Caps, power supply and accessories to be ordered separately. Ability to create various figures and light effects by overlapping profiles with the 4054 accessory.



PROFILI TAGLIATI A MISURA PERSONALIZZATA COMPLETI DI LED

Il codice del prodotto è riferito a 10 cm di modulo completo di led. Per definire la lunghezza finale del profilo considerare la misura di taglio del Led.

Composizione Codice: modulo cm 170 bianco - 19.2 NW - schermo sat = 4019.5.1.1 cm170

TAILORED CUT PROFILES WITH LED

The code of the product is referred to 10 cm of it. To define the final length of the profile consider the cut measure of the Led).

Code Composition: profile cm 170 - all - 19.2 WW - sat screen = 4019.2.6.1 cm 170

SLASH LED

Design Athena

Versione CON ALLOGGIO per alimentatore
Version WITH HOUSING for power supply unit

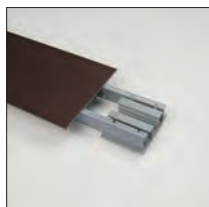

MISURA MINIMA 61 cm
MINIMUM SIZE 61 cm

Watt/m	Code - 10 cm	Color	Led
19,2	4019	4 Corten	1 4000°K
20,2	4021	5 White	6 3000°K
14,4	4024	6 Ardesia	8 2700°K
		9 Black	



Code	Linee x	Led/mt	Lm/mt	Lm/mt	Lm/mt
1+1 LINEA	W/mt		4000°K	3000°K	2700°K
4019	1+1x19,2	240+240	1580+1580	1540+1540	1490+1490
4021	1+1x20,2	224+224	3114+3114	2937+2937	2740+2740
4024	1+1x14,4	140+140	1947+1947	1836+1836	1712+1712

24 Vdc CRI90 E/F SDCM3 30.000h -20°+40° 14,4 5,1 cm - 19,2 2,5 cm - 20,2 3,57 cm IP 20

Versione SENZA ALLOGGIO per alimentatore
Version WITHOUT HOUSING for power supply unit

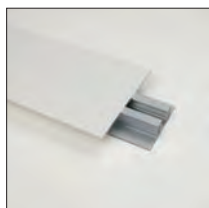

Watt/m	Code - 10 cm	Color	Led
19,2	4119	4 Corten	1 4000°K
20,2	4121	5 White	6 3000°K
14,4	4124	6 Ardesia	8 2700°K
		9 Black	



Code	Linee x	Led/mt	Lm/mt	Lm/mt	Lm/mt
1+1 LINEA	W/mt		4000°K	3000°K	2700°K
4119	1+1x19,2	240+240	1580+1580	1540+1540	1490+1490
4121	1+1x20,2	224+224	3114+3114	2937+2937	2740+2740
4124	1+1x14,4	140+140	1947+1947	1836+1836	1712+1712

24 Vdc CRI90 E/F SDCM3 30.000h -20°+40° 14,4 5,1 cm - 19,2 2,5 cm - 20,2 3,57 cm IP 20

24Vdc Led CRI 90 E/F CE IP 40

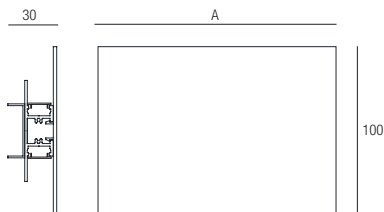

A = max cm 200

ACCESSORI Elenco completo a pag 80

SLASH

Design Athena

Profilo in alluminio nelle finiture alluminio grezzo, corten, bianco, ardesia, nero e schermi in policarbonato PMMA.

Aluminum profiles available in raw aluminum, corten, white, dark grey and black finishes with PMMA polycarbonate screens.

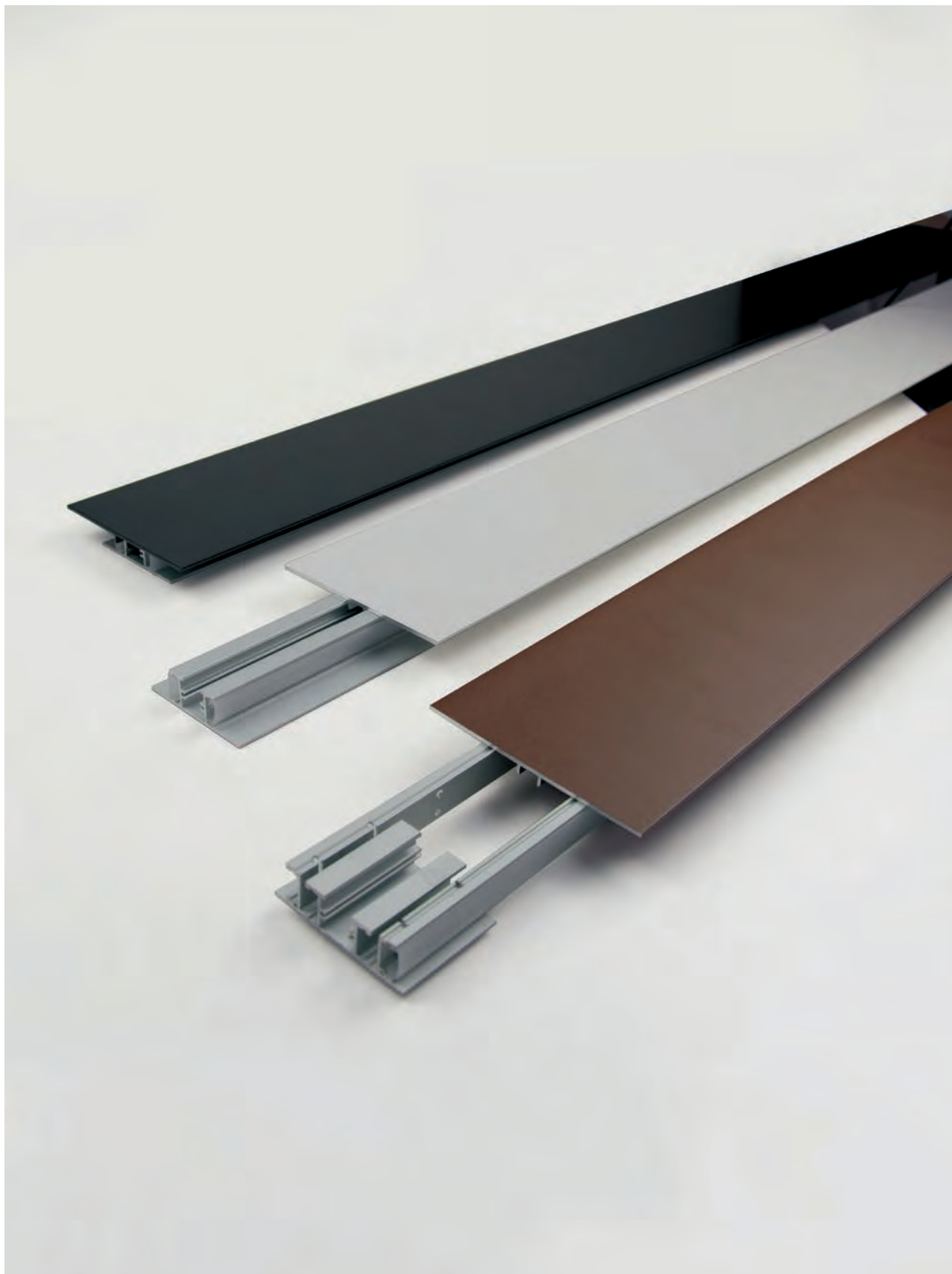

SLASH

Design Athena

Versione CON ALLOGGIO per alimentatore
Version WITH HOUSING for power supply unit

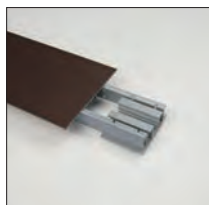

MISURA MINIMA 61 cm
MINIMUM SIZE 61 cm

Code - 10 cm	Color
4099	2 Raw Aluminium*
	4 Corten
	5 White
	6 Ardesia
	9 Black

Versione SENZA ALLOGGIO per alimentatore
Version WITHOUT HOUSING for power supply unit

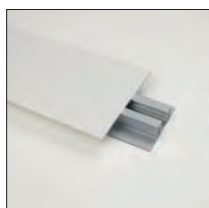

Code - 10 cm	Color
4199	2 Raw Aluminium*
	4 Corten
	5 White
	6 Ardesia
	9 Black

* Color 2 Raw Aluminium - Il profilo non subisce trattamenti di ossidazione e potrebbe presentare delle imperfezioni

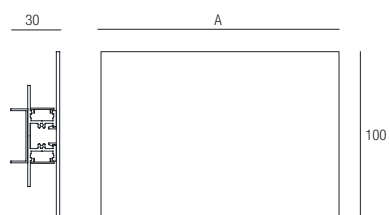

A = max cm 200

ACCESSORI Dettagli pag 80

ACCESSORI SLASH

Curva interna 90° senza Led
90° inside corner without Led

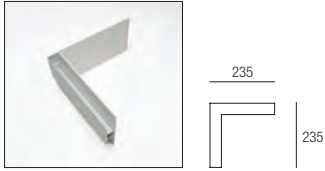

Code **Color**

9448	2 Raw Aluminium*
	4 Corten
	5 White
	6 Ardesia
	9 Black



Curva interna 90° con Led
90° inside closed corner with Led

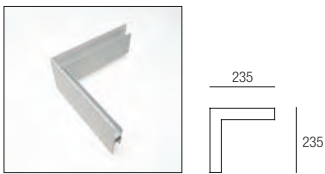

Watt/m	Code	Color	Led
19,2	944819	4 Corten	1 4000°K
20,2	944821	5 White	6 3000°K
14,4	944824	6 Ardesia	8 2700°K
		9 Black	



Code	Watt	Lumen	Lumen	Lumen	Gr
1+1 LINEE		4000°K	3000°K	2700°K	
944819	15,5w	1264	1232	1192	476
944821	17w	2616	2467	2302	476
944824	12w	1557	1489	1370	476

Curva esterna 90° senza Led
90° external corner without Led

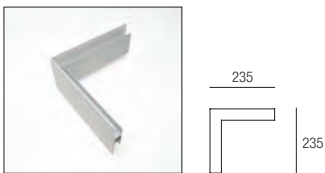

Code **Color**

9449	2 Raw Aluminium*
	4 Corten
	5 White
	6 Ardesia
	9 Black



Curva esterna 90° con Led
90° external corner with Led

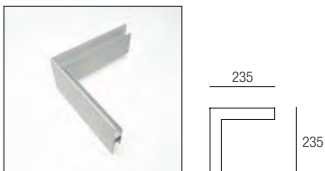

Watt/m	Code	Color	Led
19,2	944919	4 Corten	1 4000°K
20,2	944921	5 White	6 3000°K
14,4	944924	6 Ardesia	8 2700°K
		9 Black	



Code	Watt	Lumen	Lumen	Lumen	Gr
1+1 LINEE		4000°K	3000°K	2700°K	
944919	15,5w	1264	1232	1192	476
944921	17w	2616	2467	2302	476
944924	12w	1557	1489	1370	476

Curva piana 90° senza Led
90° plane corner without Led

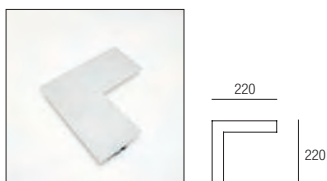

Code

9450



Color

- 2 Raw Aluminium*
- 4 Corten
- 5 White
- 6 Ardesia
- 9 Black

Curva piana 90° con Led
90° plane closed corner with Led

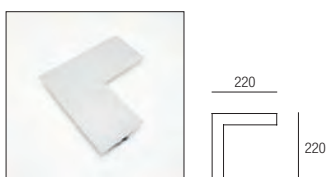

Watt/m	Code	Color	Led
19,2	945019	4 Corten	1 4000°K
20,2	945021	5 White	6 3000°K
14,4	945024	6 Ardesia	8 2700°K
		9 Black	



Code	Watt	Lumen 4000°K	Lumen 3000°K	Lumen 2700°K	Gr
1+1 LINEE					
945019	13,5w	1110	1082	1048	524
945021	14,5w	2235	2108	1966	524
945024	9w	1216	1147	1070	524

24 Vdc CRI90 E/F SDCM3 30.000h -20° +40°



ACCESSORI SLASH



Tappo
Dead-end

Code _____ **Color** _____

4051



- | | |
|----------|----------|
| 2 | Raw Iron |
| 4 | Corten |
| 5 | White |
| 6 | Ardesia |
| 9 | Black |



Set nr. 3 distanziali cm 5
Kit nr. 3 spacers cm 5

Code _____ **Color** _____

4054



- | | |
|----------|----------|
| 2 | Raw Iron |
| 4 | Corten |
| 5 | White |
| 6 | Ardesia |
| 9 | Black |



Kit alimentazione
Electricity supply kit

Code _____ **Color** _____

9857



- | | |
|----------|----------|
| 2 | Raw Iron |
| 4 | Corten |
| 5 | White |
| 6 | Ardesia |
| 9 | Black |



Elemento di congiunzione meccanico lineare
Mechanical linear connector

Code _____

9457



Elemento di congiunzione meccanico per angolo 90° verticale/orizzontale
Mechanical connector for vertical/horizontal corner 90°

Code _____

9458



Elemento di congiunzione meccanico per angolo 90° orizzontale
Mechanical connector for horizontal corner 90°

Code _____

9463



Kit 2 accessori di sicurezza per modulo a soffitto
Kit 2 safety accessory for ceiling module

Code _____

9459





ALIMENTATORI inseribili nei profili con alloggio
DRIVERS to insert into profiles with housing

Code		
1201	max 75W	24Vdc
1181	max 150W	24Vdc

CENTRALINE PER DIMMERAZIONE inseribili nei profili con alloggio
DIMMABLE DRIVERS to insert into profiles with housing

Code		
1306	max 190W	PUSH
1308	max 190W	MASTER WIRELESS+TELECOMANDO
1309	max 190W	MASTER WIRELESS+PULSANTE WIRELESS

B-LIGHT

Design Athena

Profilo in alluminio anodizzato disponibile nelle finiture alluminio, corten, bianco, ardesia e nero. Lo spessore ridotto del profilo e la possibilità di inserire due linee di luce bi-direzionale ne permettono l'utilizzo in tutti gli ambienti creando una illuminazione diffusa e d'effetto.

Anodized aluminium profile available in aluminium, corten, white, dark grey and black finishes. The reduced thickness of the profile and the possibility to insert two lines of bi-directional light, allow the usage of it in every location, creating a diffused and impressive lighting.

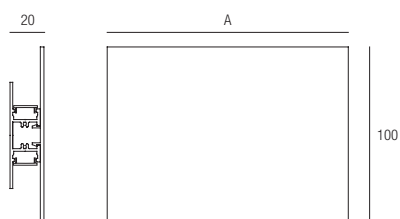
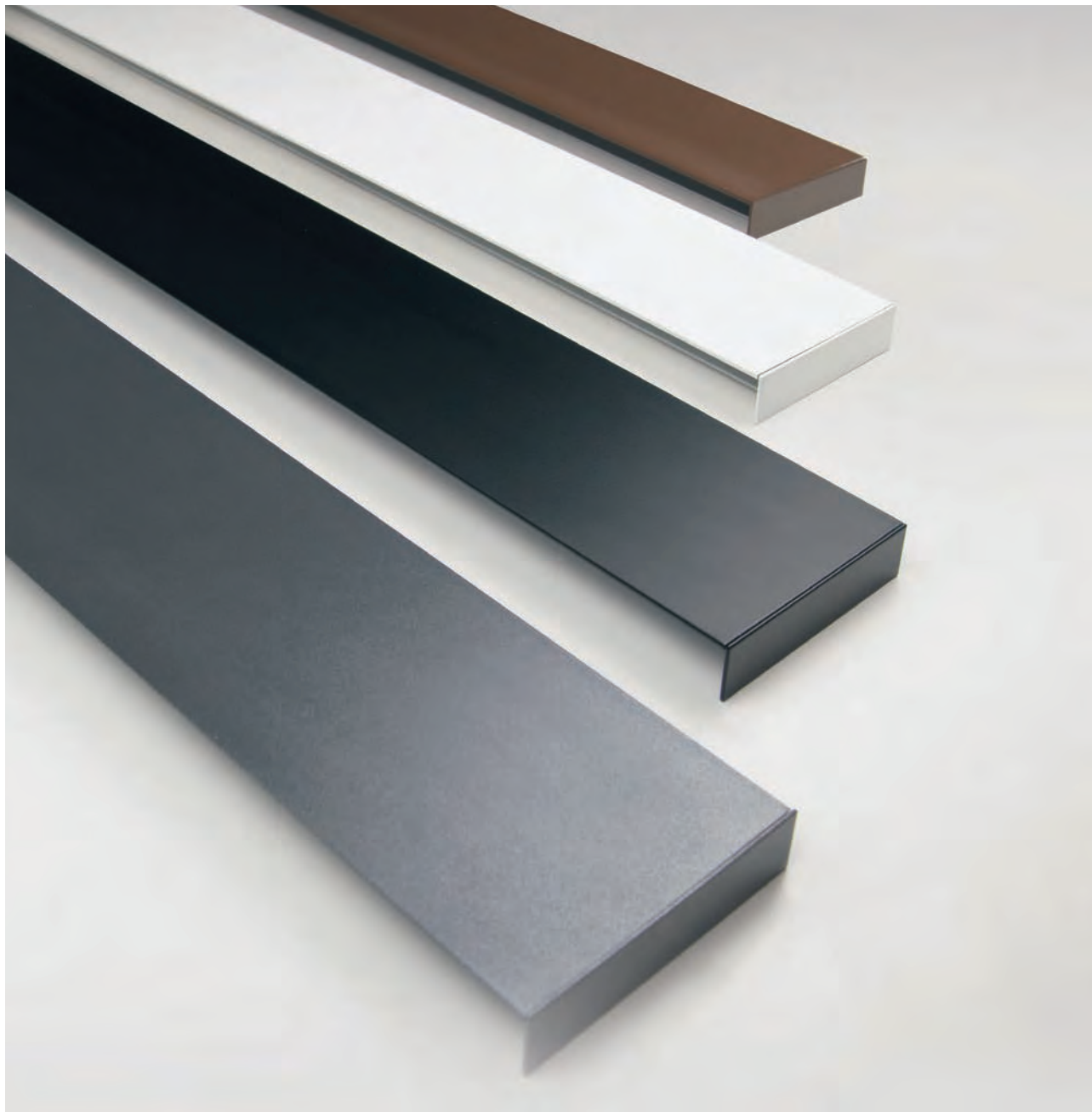

A : max cm 200

Code	Color
9493	2 Raw Aluminium
	4 Corten
	5 White
	6 Ardesia
	9 Black

Il codice del prodotto è riferito a 10 cm di profilo. In fase d'ordine precisare la misura del profilo richiesta.
Code number refer to 10 cm profile. Ordering, specify the length of the profile request.



Curva interna 90°
90° inside curve

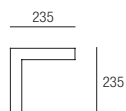

Code

Color

No Led

9448



- 2 Raw Aluminium
- 4 Corten
- 5 White
- 6 Ardesia
- 9 Black



Curva esterna 90°
External curve 90°

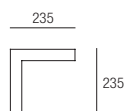

Code

Color

No Led

9449



- 2 Raw Aluminium
- 4 Corten
- 5 White
- 6 Ardesia
- 9 Black



Curva piana 90°
Plane curve 90°

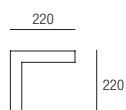

Code

Color

No Led

9450



- 2 Raw Aluminium
- 4 Corten
- 5 White
- 6 Ardesia
- 9 Black

ACCESSORI B-LIGHT







Tappo
Dead-end

Code

9456



Color

- 2  Raw Iron
- 4  Corten
- 5  White
- 6  Ardesia
- 9  Black



Elemento di congiunzione meccanico lineare
Mechanical linear connector

Code

9457



Elemento di congiunzione meccanico per angolo 90° verticale/orizzontale
Mechanical connector for vertical/horizontal corner 90°

Code

9458



Elemento di congiunzione meccanico per angolo 90° orizzontale
Mechanical connector for horizontal corner 90°

Code

9463



Kit 2 accessori di sicurezza per modulo a soffitto
Kit 2 safety accessory for ceiling module

Code

9459





MINI B-LIGHT

Design Athena

Binari in alluminio anodizzato completo di strip Led bidirezionali. Schermi in policarbonato PMMA.
Disponibile nelle finiture gold, corten, bianco, ardesia, grigio e nero. Tappi, alimentatori e accessori da ordinare separatamente.

Anodized aluminum profiles completed with 2 strip Led bi-directional. polycarbonate PMMA screens. Available in gold, corten, white, dark grey, grey and black finishes. Caps, power supply and accessories to be ordered separately.

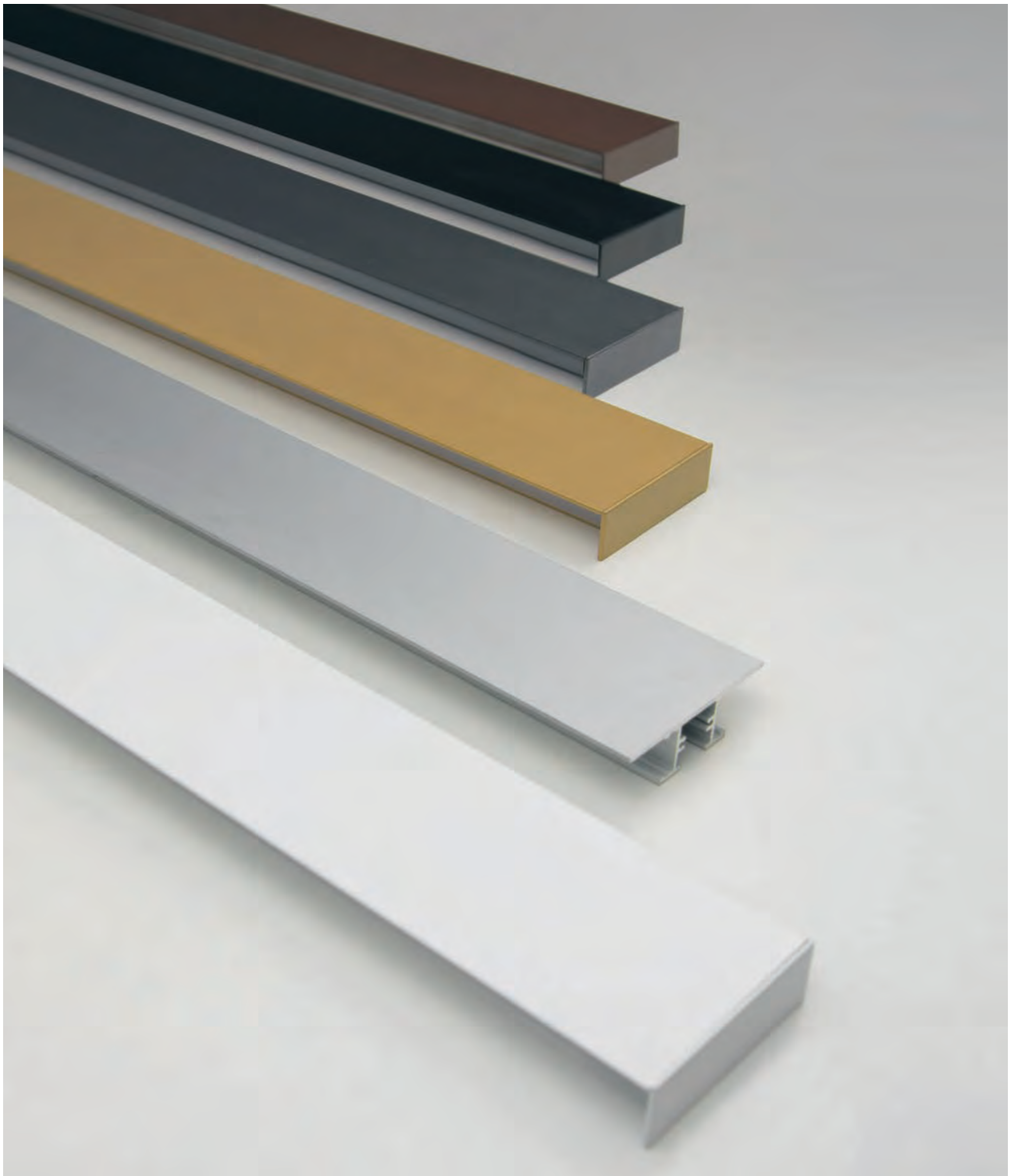

PROFILI TAGLIATI A MISURA PERSONALIZZATA COMPLETI DI LED

Il codice del prodotto è riferito a 10 cm di modulo completo di Led. Per definire la lunghezza finale del profilo considerare la misura di taglio del Led.

Composizione Codice: profilo cm 170 bianco - 2 Led x 20,2 w/m ww = 4221.5.6 cm 170.

TAILORED CUT PROFILES WITH LED

The code of the product is referred to 10 cm of it. To define the final length of the profile consider the cut measure of the Led.

Code Composition: profile cm 170 - 2 Led x 20,2 w/m ww = 4221.5.6 cm 170.

MINI B-LIGHT LED

Design Athena



Watt/m	Code - 10 cm	Color	Led
19,2	4219	3 Gold	1 4000°K
20,2	4221	4 Corten	6 3000°K
14,4	4224	5 White	8 2700°K
		6 Ardesia	
		7 Grey	
		9 Black	

Code	Linee x	Led/mt	Lm/mt	Lm/mt	Lm/mt
1+1 LINEE	W/mt		4000°K	3000°K	2700°K
4219	1+1x19,2	480	1580+1580	1540+1540	1490+1490
4221	1+1x20,2	448	3114+3114	2937+2937	2740+2740
4224	1+1x14,4	280	1947+1947	1836+1836	1712+1712

24 Vdc CRI90 E/F SDCM3 30.000h -20° +40° 14,4 5,1 cm - 19,2 2,5 cm - 20,2 3,57 cm

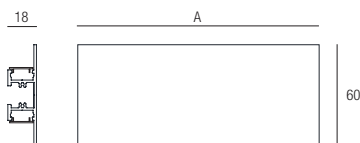

A: 3 max cm 200 - 4-5-6-7-9 max cm 300

Led CRI >90 CE IP 40

MINI B-LIGHT

Design Athena

Profilo in alluminio anodizzato nelle finiture alluminio, gold, corten, bianco, ardesia, grigio e nero.

Schermi in policarbonato PMMA. È previsto l'inserimento nel profilo di uno o due strip bi-direzionali. Installabili a parete, soffitto o come zoccolino segna passo. Tappi, alimentatori e accessori da ordinare separatamente.

Anodized aluminium profile available in aluminium, gold, corten, white, dark grey, grey and black finishes. Polycarbonate PMMA screens. One or two bi-directional led lines can be insert into the profile. it can be installed on the wall, ceiling or as wall path marker. Caps, power supply and accessories to be ordered separately.



MINI B-LIGHT

Design Athena



Code - 10 cm	Color
4299	2 Raw Aluminium
	3 Gold
	4 Corten
	5 White
	6 Ardesia
	7 Grey
	9 Black

ACCESSORI MINI B-LIGHT

Curva interna 90° senza Led
90° inside corner without Led

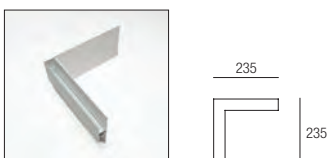

Code	Color	No Led
4248	2 Raw Aluminium	
	3 Gold	
	4 Corten	
	5 White	
	6 Ardesia	
	7 Grey	
	9 Black	

Curva interna 90° con Led
90° inside corner with Led

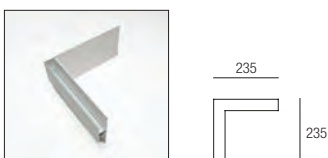

Watt/m	Code	Color	Led
19,2	424819	3 Gold	1 4000°K
20,2	424821	4 Corten	6 3000°K
14,4	424824	5 White	8 2700°K
		6 Ardesia	
		7 Grey	
		9 Black	

Code	Watt	Lumen	Lumen	Lumen
1+1 LINEE		4000°K	3000°K	2700°K
424819	15,5w	1264	1232	1192
424821	17w	2616	2467	2302
424824	12w	1557	1489	1370

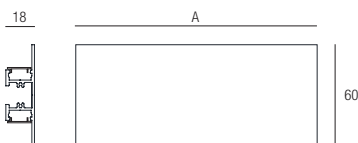

A: 2 max cm 400 - 3 max cm 200 - 4-5-6-7-9 max cm 300

ACCESSORI MINI B-LIGHT

Curva esterna 90° senza Led
90° external corner without Led

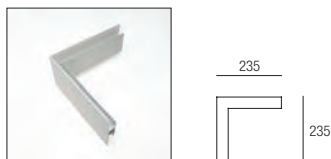

Code **Color** **No Led**

Code	Color	No Led
4249	2 Raw Aluminium	
	3 Gold	
	4 Corten	
	5 White	
	6 Ardesia	
	7 Grey	
	9 Black	



Curva esterna 90° con Led
90° external corner with Led

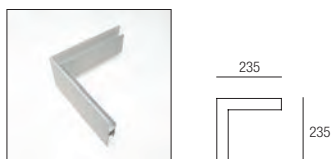

Watt/m **Code** **Color** **Led**

Watt/m	Code	Color	Led
19,2	424919	3 Gold	1 4000°K
20,2	424921	4 Corten	6 3000°K
14,4	424924	5 White	8 2700°K



Code	Watt	Lumen	Lumen	Lumen
1+1 LINEE		4000°K	3000°K	2700°K
424919	15,5w	1264	1232	1192
424921	17w	2616	2467	2302
424924	12w	1557	1489	1370

Curva piana 90° senza Led
90° plane corner without Led

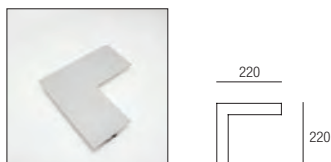

Code **Color** **No Led**

Code	Color	No Led
4250	2 Raw Aluminium	
	3 Gold	
	4 Corten	
	5 White	
	6 Ardesia	
	7 Grey	
	9 Black	



Curva piana 90° con Led
90° plane corner with Led

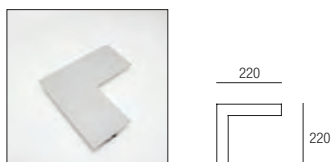

Watt/m **Code** **Color** **Led**

Watt/m	Code	Color	Led
19,2	425019	3 Gold	1 4000°K
20,2	425021	4 Corten	6 3000°K
14,4	425024	5 White	8 2700°K



Code	Watt	Lumen	Lumen	Lumen
1+1 LINEE		4000°K	3000°K	2700°K
425019	13,5w	1110	1082	1048
425021	14,5w	2235	2108	1966
425024	9w	1216	1147	1070



Tappo
Dead-end

Code

4251



Color

- 2 Raw Iron
- 3 Gold
- 4 Corten
- 5 White
- 6 Ardesia
- 7 Grey
- 9 Black



Supporto parete/soffitto
Wall/ceiling support

Code

4256



Elemento di congiunzione meccanico lineare
Mechanical linear connector

Code

9457



Elemento di congiunzione meccanico per angolo 90° verticale/orizzontale
Mechanical connector for vertical/horizontal corner 90°

Code

9458



Elemento di congiunzione meccanico per angolo 90° orizzontale
Mechanical connector for horizontal corner 90°

Code

9463



MICRO

Design Athena

Profilo in alluminio anodizzato completo di strip led. Schermo in policarbonato. Cavo alimentazione mm 2000.

Anodized aluminium profile complete with strip led. Polycarbonate screen. Cable mm 2000.



PROFILI TAGLIATI A MISURA PERSONALIZZATA COMPLETI DI LED

Il codice del prodotto è riferito a 10 cm di modulo completo di led. Per definire la lunghezza finale del profilo considerare la misura di taglio del led.

Composizione Codice: modulo cm 270 bianco - 19.2 WW - schermo sat = 949519.5.6.1 cm 270

TAILORED CUT PROFILES WITH LED

The code of the product is referred to 10 cm of it. To define the final length of the profile consider the cut measure of the led.

Code Composition: profile cm 270 - all - 19.2 WW - sat screen = 949519.2.6.1 cm 270

MICRO LED

Design Athena

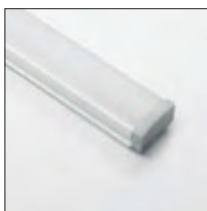

Watt/m	Code - 10 cm	Color	Led
19,2	949519	2 Aluminium	1 4000°K
20,2	949521	3 Gold	6 3000°K
14,4	949524	4 Corten	8 2700°K
		5 White	
		6 Ardesia	
		9 Black	

Code	W/mt	Led/mt	Lm/mt 4000°K	Lm/mt 3000°K	Lm/mt 2700°K
949519	19,2	240	1580	1540	1490
949521	20,2	224	3114	2937	2740
949524	14,4	140	1947	1836	1712

24 Vdc CRI90 E/F SDCM3 30.000h -20° +40° 14,4 5,1 cm - 19,2 2,5 cm - 20,2 3,57 cm

SCHERMI

ACCESSORI Dettagli pag 97



1 Satinato 2 Trasparente 3 Lente 40°/Trasp.



A: Color: 2 max cm 400 - 3 max cm 200 - 4-5-6-9 max cm 300

Led CRI >90 E/F CE IP 40

MICRO

Design Athena

Profilo in alluminio anodizzato con schermo in policarbonato.
Anodized aluminium profile complete with polycarbonate screen.



MICRO

Design Athena



Code - 10 cm

9495

Color

- 2  Aluminium
- 3  Gold
- 4  Corten
- 5  White
- 6  Ardesia
- 9  Black

SCHERMI



- 1 Satinato 2 Trasparente 3 Lente 40°/Trasp.

ACCESSORI MICRO

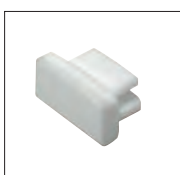

Tappo
Dead-end

Code

9453 senza foro

9454 con foro



Lavorazione taglio orizzontale ad angolo 45° dei profili
Horizontal 45° cutting of the profiles

Code

9660



Supporto parete/soffitto
Wall/ceiling support

Code

9656

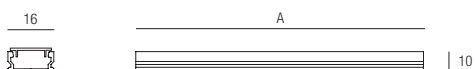

A: 2 max cm 400 - 3 max cm 200 - 4-5-6-9 max cm 300

Il codice del prodotto è riferito a 10 cm di profilo. In fase d'ordine precisare la misura del profilo richiesta.
Code number refer to 10 cm profile. Ordering, specify the length of the profile request.

ANGOLARE LED

Design Athena

Sistema modulare componibile composto da binari in alluminio anodizzato completi di 2 strip led bidirezionali. Schermi in policarbonato PMMA . Applicazione ad angolo tra soffitto e parete oppure tra due pareti. Disponibile nella finitura bianco e nero. Tappi, alimentatori ed accessori da ordinare separatamente.

Modular system composed of anodized aluminium completed with 2 bi-directional strip led . Polycarbonate PMMA screens. Corner application between ceiling and wall or between two walls. Available in white and black finishes. Caps, power supply and accessories to be ordered separately.

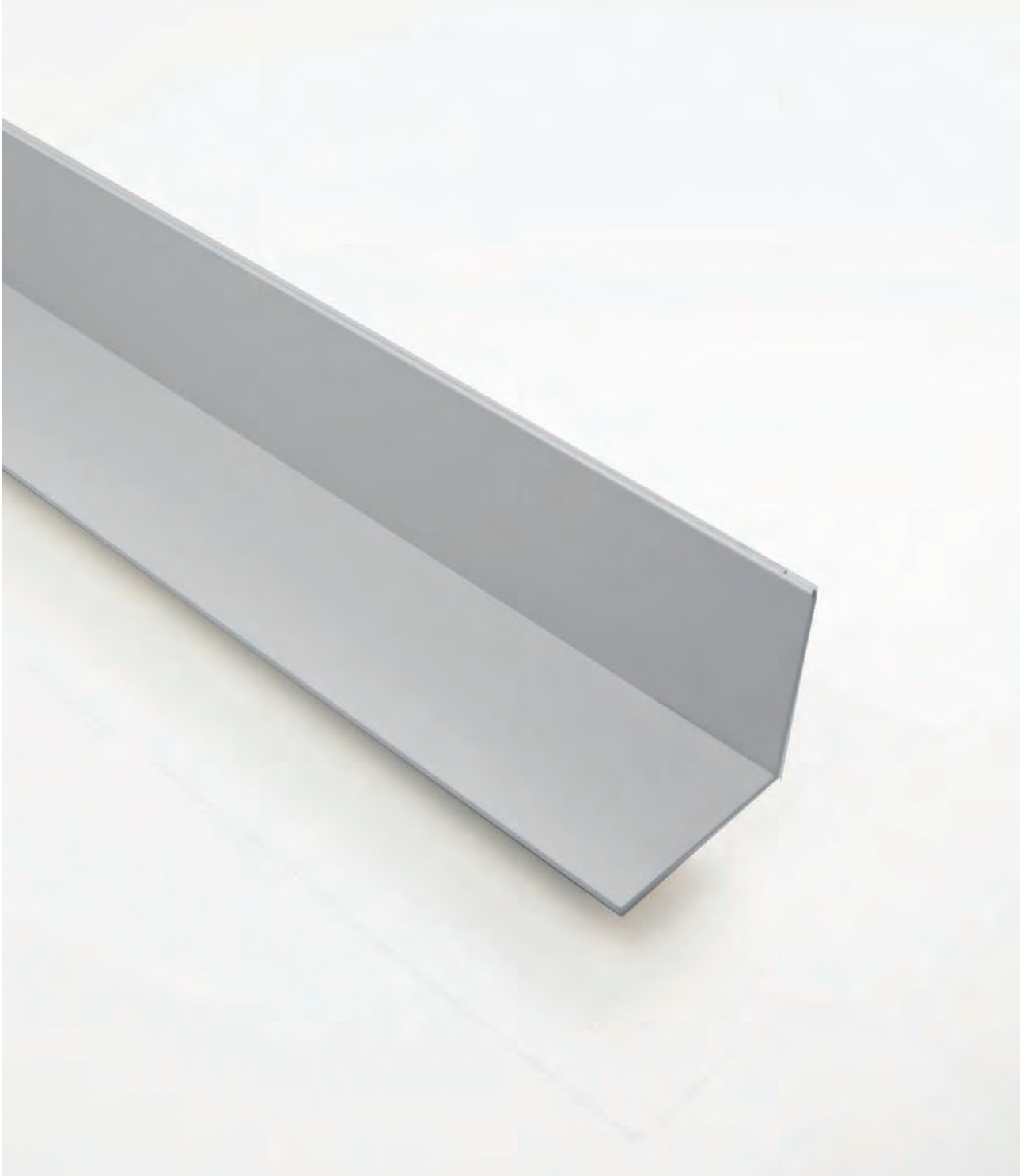

PROFILI TAGLIATI A MISURA PERSONALIZZATA COMPLETI DI LED

Il codice del prodotto è riferito a 10 cm di profilo completo di Led. Per definire la lunghezza finale del profilo considerare la misura di taglio del Led.

Composizione Codice: profilo cm 170 bianco - 2x2 led x20,2 w/m ww = 4521.5.6 cm170

TAILORED CUT PROFILES WITH LED

The code of the product is referred to 10 cm of it. To define the final length of the profile consider the cut measure of the Led.

Code Composition: Profile cm 170 white —2 led x20,2 w/m ww = 4521.5.6 cm170

ANGOLARE LED

Design Athena

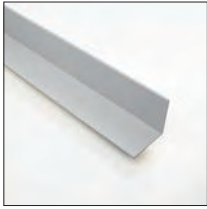

Watt	Code - 10 cm	Color	Led
19,2	4519	5 White	1 4000°K
20,2	4521	9 Black	6 3000°K
14,4	4524		8 2700°K



Code	Linee x W/mt	Led/mt	Lm/mt 4000°K	Lm/mt 3000°K	Lm/mt 2700°K
4519	1+1x19,2	240+240	1580+1580	1540+1540	1490+1490
4521	1+1x20,2	224+224	3114+3114	2937+2937	2740+2740
4524	1+1x14,4	140+140	1947+1947	1836+1836	1712+1712

24 Vdc CRI90 SDCM3 30.000h -20° +40° 14,4 5,1 cm - 19,2 2,5 cm - 20,2 3,57 cm

ALIMENTATORI inseribili nel profilo angolare
DRIVERS to insert into profile angolare

Code	
1183	max 20W 24Vdc (non dimmerabile)
1201	max 75W 24Vdc
1181	max 150W 24Vdc

CENTRALINE PER DIMMERAZIONE inseribili nel profilo angolare
DIMMABLE DRIVERS to insert into into profile angolare

Code	
1306	190W PUSH
1308	190W RF - PUSH + TELECOMANDO 4 ZONE WIRELESS
1309	190W RF - PUSH + PULSANTE wireless
1311	2x120W RF-PUSH (2CH) APP TUYA - ALEXA - AMAZON ECHO

Specifiche tecniche da pag 310

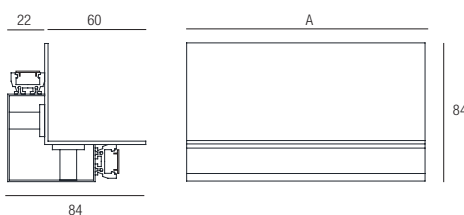

A: min cm 50 - max cm 300

ACCESSORI ANGOLARE



Tappo
Dead-end

Code

4551



Color

5  White
9  Black



Kit 2 congiunzioni meccaniche
2 straight mechanical connectors

Code

96532





VELA

Design Athena

Profilo in estruso di alluminio anodizzato. Utilizzabile per applicazioni con cartongesso e adatto per installazioni perimetrali.

Extruded profile in anodized aluminium. It can be used for drywall applications and it is suitable for perimeter installations.

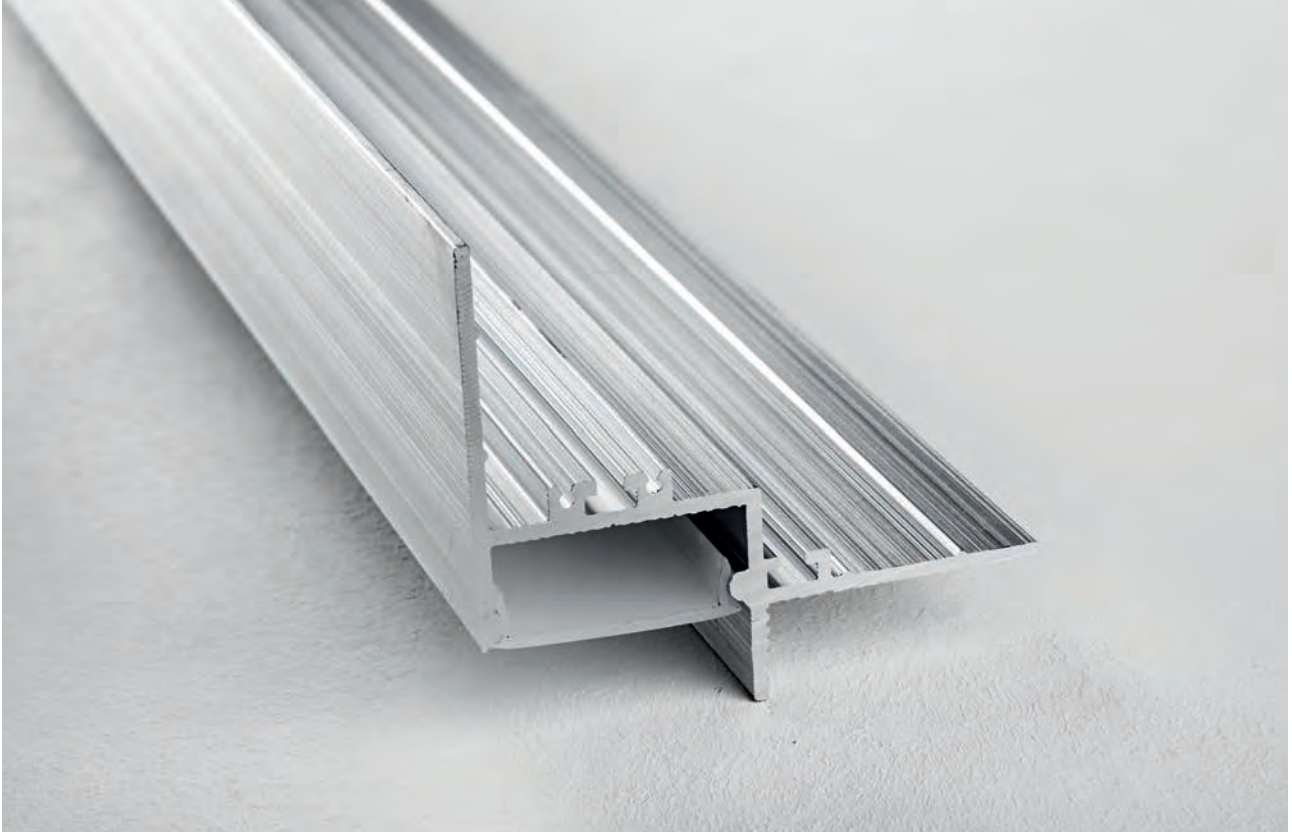

Code - 10 cm

Color

9494

2 Aluminium

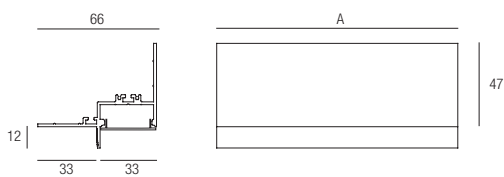

A: max cm 400

Il codice del prodotto è riferito a 10 cm di profilo. In fase d'ordine precisare la misura del profilo richiesta.
Code number refer to 10 cm profile. Ordering, specify the length of the profile request.

ACCESSORI VELA



Tappo
Dead-end

Code _____

9455



Elemento di congiunzione meccanico
Straight mechanical connector

Code _____

9653



Elemento di congiunzione meccanico per angolo 90° orizzontale
Mechanical connector for horizontal corner 90°

Code _____

9657



Schema di installazione
Installation scheme

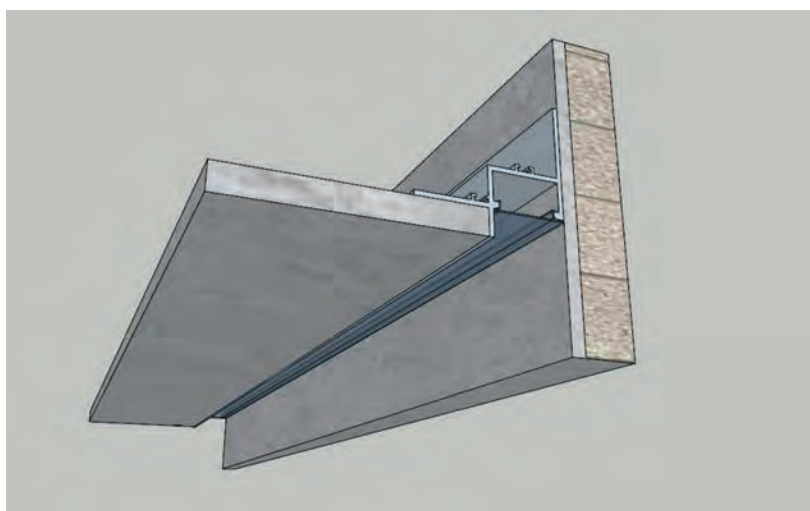

KAPPA

Design Athena

Profilo in alluminio anodizzato con schermo in policarbonato.

Anodized aluminium profile complete with polycarbonate screen.



SCHERMI

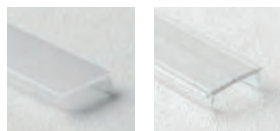

1 Satinato

2 Trasparente

Code - 10 cm

9499

Color

2  Aluminium

ACCESSORI

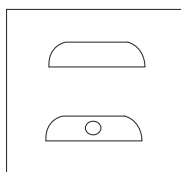

Tappo
Dead-end

Code

9451 senza foro

9452 con foro



Lavorazione taglio ad angolo 45° dei profili
45° cutting of the profiles

Code

9660

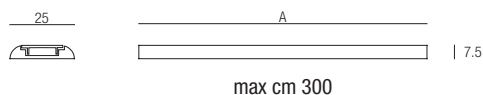

Il codice del prodotto è riferito a 10 cm di profilo. In fase d'ordine precisare la misura del profilo richiesta.
Code number refer to 10 cm profile. Ordering, specify the length of the profile request.

PIATTO

Design Athena

Piatto alluminio per dissipazione del calore.
Aluminium bar for heat dissipation.



Code - 10 cm	Color
9491	2  Aluminium

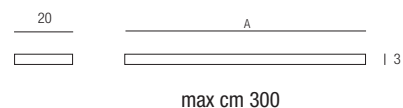

Code - 10 cm	Color
9492	2  Aluminium

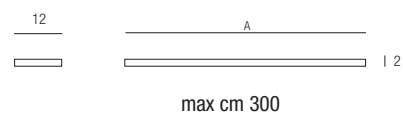

OMEGA

Design Athena

Profilo in alluminio anodizzato. Schermo in policarbonato PMMA, cavo alimentazione mm 2000.

Anodized aluminium profile and polycarbonate PMMA screen. Wire length mm 2000.



OMEGA WET IP67

Design Athena

Profilo in alluminio anodizzato completo di strip LED e inserito in tubo trasparente idoneo per IP67. Schermo in policarbonato. Completo di attacco parete/soffitto, tappo di chiusura e cavo di alimentazione Fror cm 200. Idoneo per ambienti interni ed esterni.

Anodized aluminium profile completed with strip, inserted in an IP67 clear tube. Polycarbonate screen. For indoor and outdoor environments. Complete with wall/ceiling connection, closure plug and 200 cm.

CAVO DI ALIMENTAZIONE FROR CM. 200 + TAPPO



Watt/m	Code - 10 cm	Color	Led
9,6	95510	2 Aluminium	1 4000°K
14,4	95524		6 3000°K
			8 2700°K



Code	W/mt	Led/mt	Lm/mt 4000°K	Lm/mt 3000°K	Lm/mt 2700°K
95510	9,6	120	887	837	
95524	14,4	240	1947	1836	1712

24 Vdc CRI80-90 SDCM3 30.000h -20°+40° 9,6 5 cm - 14,4 5,1 cm

SCHERMI

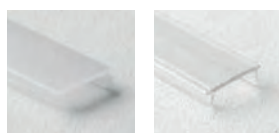

1 Satinato 2 Trasparente

PROFILI TAGLIATI A MISURA INSERITI IN TUBO TRASPARENTE E COMPLETI DI STRIP LED
 Il codice del prodotto è riferito a 10 cm di profilo inserito in tubo trasparente e completo di strip led.
 Per definire la lunghezza finale del binario considerare la misura di taglio della strip + misura serracavo.

TAILORED CUT PROFILES INSERT IN A CLEAR TUBE AND COMPLETED WITH LED STRIP
 The code of the product is referred to 10 cm of it.
 To define the final length of the profile consider the cut measure of the strip + measure of the cablestopping.

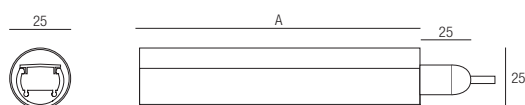

A = max cm 300

Led CRI 80-90 IP 67

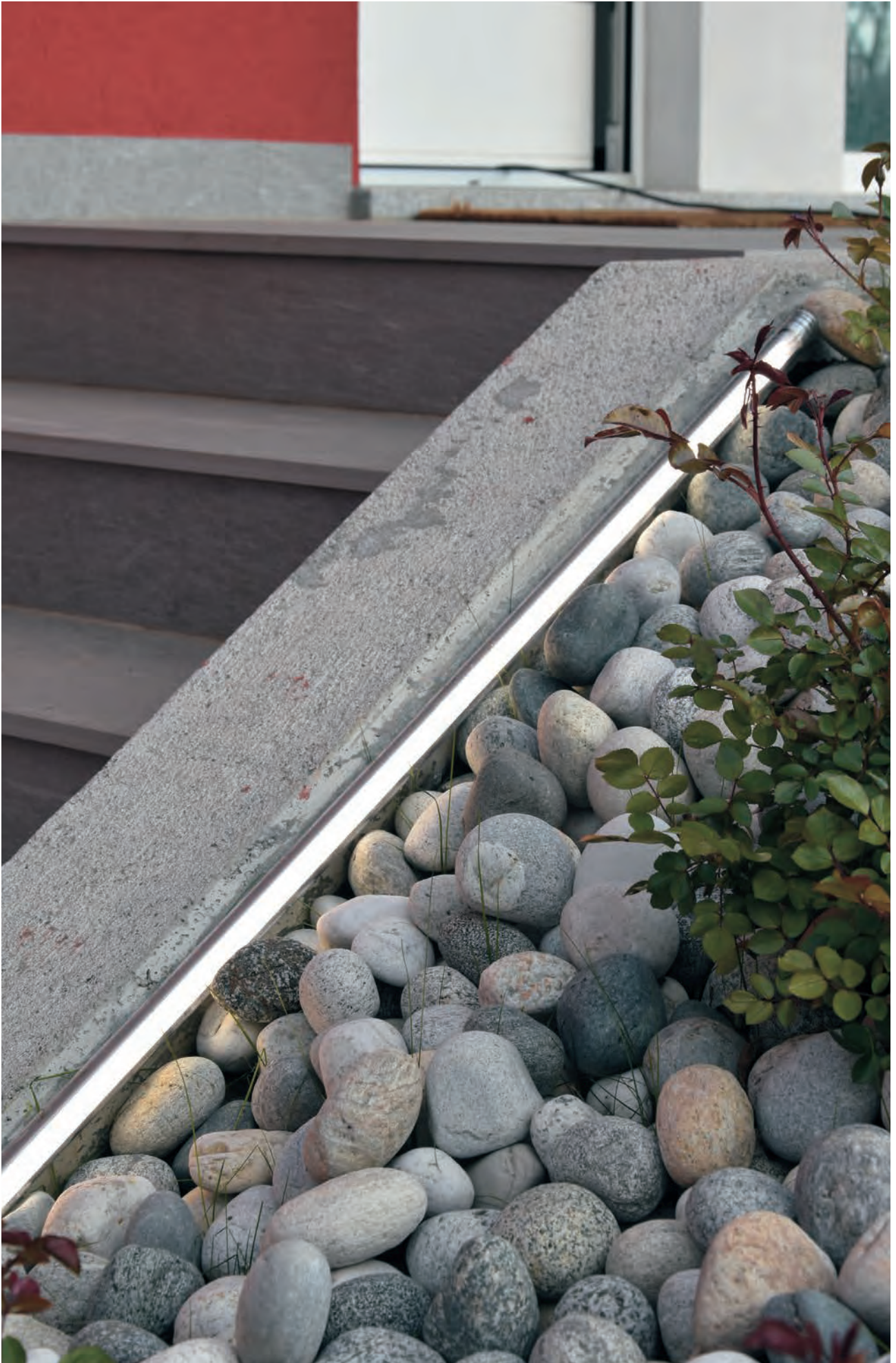

CAVO DI ALIMENTAZIONE FROR CM. 200 + CAVO FROR CM 20



Watt/m	Code - 10 cm	Color	Led
9,6	95610	2 Aluminium	1 4000°K
14,4	95624		6 3000°K
			8 2700°K



Code	W/mt	Led/mt	Lm/mt 4000°K	Lm/mt 3000°K	Lm/mt 2700°K
95610	9,6	120	887	837	
95624	14,4	240	1947	1836	1712

24 Vdc CRI80-90 SDCM3 30.000h -20° + 40° 9,6 5 cm - 14,4 5,1 cm

SCHERMI

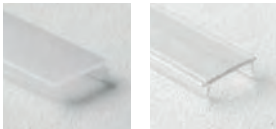

1 Satinato 2 Trasparente

PROFILI TAGLIATI A MISURA INSERITI IN TUBO TRASPARENTE E COMPLETI DI STRIP LED
 Il codice del prodotto è riferito a 10 cm di profilo inserito in tubo trasparente e completo di strip led.
 Per definire la lunghezza finale del binario considerare la misura di taglio della strip + misura serracavo.

TAILORED CUT PROFILES INSERT IN A CLEAR TUBE AND COMPLETED WITH LED STRIP
 The code of the product is referred to 10 cm of it.
 To define the final length of the profile consider the cut measure of the strip + measure of the cablestopping.

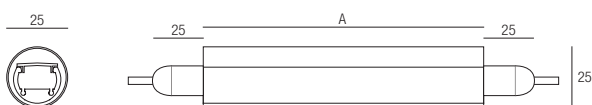

A = max cm 300

Led CRI 80-90 CE IP 67

OMEGA

Design Athena

Profilo in alluminio anodizzato con schermo in policarbonato PMMA.

Anodized aluminium profile complete with polycarbonate screen PMMA.



SCHERMI

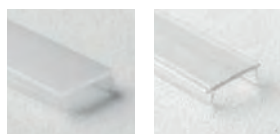

1 Satinato

2 Trasparente

Code

959920 mt.2

959930 mt.3

Color

2  Aluminium

ACCESSORI



Tappo

Dead-end

Code

9551 senza foro

9552 con foro



Supporto parete/soffitto

Wall/ceiling adjustable support

Code

9555

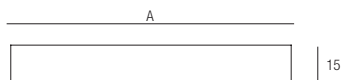

A = max cm 300

Il codice del prodotto è riferito a 10 cm di profilo. In fase d'ordine precisare la misura del profilo richiesta.
Code number refer to 10 cm profile. Ordering, specify the length of the profile request.



RESINATI IP67

Design Athena

Profilo in alluminio anodizzato completo di strip led e copertura in resina satinata. Cavo di alimentazione FROR mm 2000. Grado di protezione IP67. Adatto sia ambienti interni che esterni.

Anodized aluminium profile and completed with led strips and satin resin coverage. Power cord FROR mm 2000. Protection degree IP67. Suitable for both inters and outdoors.



PROFILI TAGLIATI A MISURA PERSONALIZZATA COMPLETI DI LED

Il codice del prodotto è riferito a 10 cm di modulo completo di led. Per definire la lunghezza finale del profilo considerare la misura di taglio del led.

Composizione Codice: modulo Delta cm 270 bianco - 14,4 WW - schermo sat = 96424.5.6 cm270

TAILORED CUT PROFILES WITH LED

The code of the product is referred to 10 cm of it. To define the final length of the profile consider the cut measure of the led.

Code Composition: profile Delta cm 270 - all - 14.4 WW - sat screen = 96424.2.6 cm270

RESINATI DELTA IP67

Design Athena



Watt/m	Code - 10 cm	Color	Led
9,6	96410	2 Aluminium	1 4000°K
20,2	96421	4 Corten	6 3000°K
14,4	96424	5 White	8 2700°K
		6 Ardesia	

Code	W/mt	Led/mt	Lm/mt 4000°K	Lm/mt 3000°K	Lm/mt 2700°K
96410	9,6	120	887	837	
96421	20,2	224	3114	2937	2740
96424	14,4	140	1947	1836	1712

24 Vdc CRI80-90 C/F SDCM3 30.000h -20° +40° 9,6 5 cm 14,4 5,1 cm 20,2 3,57 cm

RESINATI SLASH IP67 a richiesta

A richiesta cavo FROR da entrambi i lati per il collegamento di più binari.

ACCESSORI



Supporto parete/soffitto
Wall/ceiling adjustable support

Code

9656

1,50

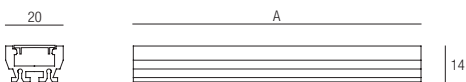

max cm 300

Led CRI >80-90 CE IP 67

RESINATI SIHON IP67

Design Athena



Watt/m	Code - 10 cm	Color	Led
9,6	93410	2 Aluminium	1 4000°K
20,2	93421	4 Corten	6 3000°K
14,4	93424	5 White	8 2700°K



Code	W/mt	Led/mt	Lm/mt 4000°K	Lm/mt 3000°K	Lm/mt 2700°K
93410	9,6	120	887	837	
93421	20,2	224	3114	2937	2740
93424	14,4	140	1947	1836	1712

24 Vdc CRI80-90 SDCM3 30.000h -20° +40° 9,6 5 cm 14,4 5,1 cm 20,2 3,57 cm

A richiesta cavo FROR da entrambi i lati per il collegamento di più binari.

ACCESSORI



Controcassa per incasso murature e laterizio
Utilizzare con molle 9353

Casing for brickwork
Use with 9354 springs

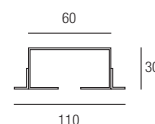

Code - 10 cm

930599



Controcassa per incasso murature e laterizio
Utilizzare con molle 9354

Casing for brickwork
Use with 9354 springs

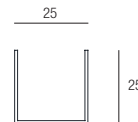

Code - 10 cm

930595

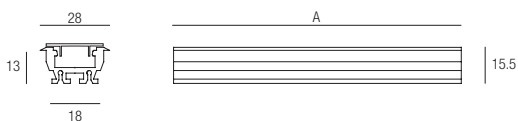

max cm 300

Led CRI >80-90 CE IP 67

RESINATI TAU IP67

Design Athena



Watt/m	Code - 10 cm	Color	Led
9,6	91410	2 Aluminium	1 4000°K
20,2	91421	4 Corten	6 3000°K
14,4	91424	5 White	8 2700°K
		6 Ardesia	

Code	W/mt	Led/mt	Lm/mt 4000°K	Lm/mt 3000°K	Lm/mt 2700°K
91410	9,6	120	887	837	
91421	20,2	224	3114	2937	2740
91424	14,4	140	1947	1836	1712

24 Vdc CRI80-90 SDCM3 30.000h -20° + 40° 9,6 5 cm 14,4 5,1 cm 20,2 3,57 cm

A richiesta cavo FROR da entrambi i lati per il collegamento di più binari.

ACCESSORI



Supporto parete/soffitto
Wall/ceiling adjustable support

Code _____

9656

1,50

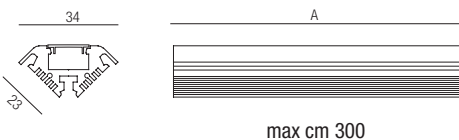

max cm 300

Led CRI >80-90 CE IP 67

RESINATI MICRO IP67

Design Athena

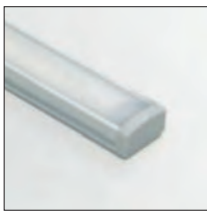

Watt/m	Code - 10 cm	Color	Led
9,6	9495410	2 Aluminium	1 4000°K
20,2	9495421	4 Corten	6 3000°K
14,4	9495424	5 White	8 2700°K
		6 Ardesia	

Code	W/mt	Led/mt	Lm/mt 4000°K	Lm/mt 3000°K	Lm/mt 2700°K
9495410	9,6	120	887	837	
9495421	20,2	224	3114	2937	2740
9495424	14,4	140	1947	1836	1712

24 Vdc CRI80-90 SDCM3 30.000h -20° +40° 9,6 5cm 14,4 5,1cm 20,2 3,57cm

A richiesta cavo FROR da entrambi i lati per il collegamento di più binari.

ACCESSORI



Supporto parete/soffitto
Wall/ceiling adjustable support

Code

9656

1,50

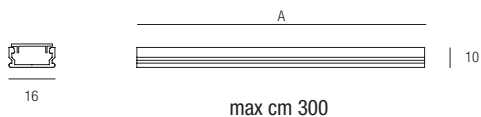

Led CRI >80-90 CE IP67



ETHA IP67

Design Athena

Profilo CALPESTABILE in alluminio anodizzato. Schermo in policarbonato completo di strip Led e cavo alimentazione mm 2000. Grado di protezione IP67. Adatto per ambienti interni.

WALKABLE anodized aluminium profile. Polycarbonate complete with strip led and wire length mm 2000. Degree of protection IP67. Suitable for indoor environments.

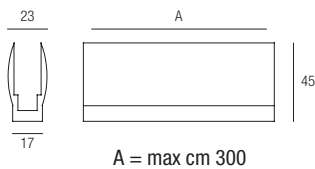

Cassaforma senza bordo
Anodized aluminium profile

Code - 10 cm

Color

9298

2  Aluminium

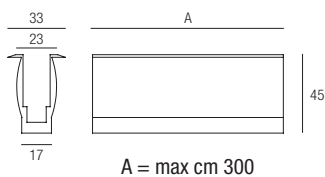

Cassaforma con bordo
Anodized aluminium profile

Code - 10 cm

Color

9299

2  Aluminium

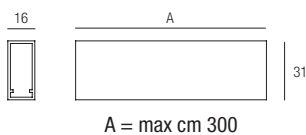

Policarbonato con strip Led
Polycarbonate with strip Led

Watt/m

Code - 10 cm

Led

9,6

9210

1  4000°K

14,4

9224

6  3000°K

8  2700°K

Code	W/mt	Led/mt	Lm/mt 4000°K	Lm/mt 3000°K	Lm/mt 2700°K
9210	9,6	120	887	837	
9224	14,4	140	1947	1836	1712

24 Vdc CRI 80-90  SDCM3  30.000h  -20° +40°  9,6 5 cm - 14,4 5,1 cm 

POLICARBONATO TAGLIATO A MISURA COMPLETO DI STRIP LED E CAVO FROR 2x0,50 CM 200

Il codice del prodotto è riferito a 10 cm di modulo completo di led.

Per definire la lunghezza finale del binario considerare multipli da 5 cm + 4 cm per i tappi di chiusura e il cablaggio.

TAILORED CUT PROFILES COMPLETED WITH LED STRIPS

The code of the product is referred to 10 cm of it.

To define the final length of the profile consider multiples of 5 cm + 4 cm for the closing tops and the wiring.

Led CRI 80-90  CE IP67   



STRIP FLEX 20,2 W/MT 224 LED/MT - CRI 90 - IP 20

Strip Led flessibile 20,2 w/mt con biadesivo 3M, cavo alimentazione rosso/nero cm 30.

Flexible 20,2 w/mt strip Led, red/black cable cm 30.

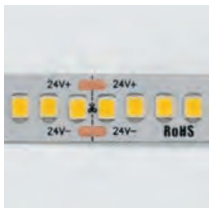

Code		W/mt	Led/mt	Lm/mt 4000°K	Lm/mt 3000°K	Lm/mt 2700°K
979020	3,57 cm - 8 Led	20,2	224	3114	2937	2740
979029						

ROLLA - 500 cm

Led

979020







1 4000°K

6 3000°K

STRIP - 10 cm

8 2700°K

979029

IP 20 CRI90 - SDCM3 - SMD2835
 24 Vdc Led - input current 0,84 A/MT
 30.000h  -20° + 40° 
 Led CRI90   IP 20 

Installare su superfici dissipanti il calore. Applicazione in luoghi asciutti in ambienti interni.
 Install only on dissipating surfaces. Application on a dry place indoors.

Il codice 979029 è riferito a 10 cm. Per definire la lunghezza della strip considerare la misura di taglio Led.
 Code 979029 is referred to 10cm. To define the final length consider the cut measure of the Led.

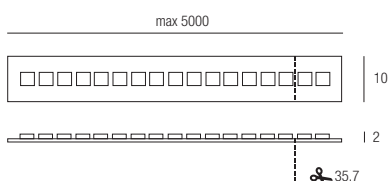







STRIP FLEX 19,2 W/MT 240 LED/MT - CRI 90 - IP 20

Strip Led flessibile 19,2 w/mt con biadesivo 3M, cavo alimentazione rosso/nero cm 30.
Flexible 19,2 w/mt strip Led, red/black cable cm 30



ROLLA - 500 cm	Led
979060	1 4000°K
	6 3000°K
STRIP - 10 cm	8 2700°K
	979069

Code		W/mt	Led/mt	Lm/mt 4000°K	Lm/mt 3000°K	Lm/mt 2700°K
979060	2,5 cm - 6 Led	19,2	240	1580	1540	1490
979069						

IP 20 CRI90 - SDCM3 - SMD3528
24 Vdc Led - input current 0,84 A/MT
30.000h  -20° + 40° 
Led CRI90   IP 20 

Installare su superfici dissipanti il calore. Applicazione in luoghi asciutti in ambienti interni.
Install only on dissipating surfaces. Application on a dry place indoors.

Il codice 979069 è riferito a 10 cm. Per definire la lunghezza della strip considerare la misura di taglio Led.
Code 979069 is referred to 10cm. To define the final length consider the cut measure of the Led.

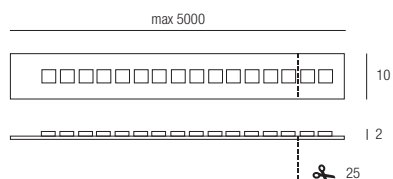







STRIP FLEX 14,4 W/MT 140 LED/MT - CRI 90 - IP 20

Strip Led flessibile con biadesivo 3M, 14,4 w/mt,cavo alimentazione rosso/nero cm 30.
Flexible strip Led, 14,4 w/mt, red/black cable cm 30.



ROLLA - 500 cm	Led
999040	1 4000°K
	6 3000°K
STRIP - 10 cm	8 2700°K
999049	

Code		W/mt	Led/mt	Lm/mt 4000°K	Lm/mt 3000°K	Lm/mt 2700°K
999040	5,1 cm - 7 Led	14,4	140	1947	1836	1712
999049						

IP 20 CRI90 - SDCM3 - SMD2835
24 Vdc Led - input current 0,6 A/MT
30.000h  -20° + 40° 
Led CRI90   IP 20 





STRIP FLEX 14,4 W/MT 140 LED/MT - CRI 90 - IP 64

Strip Led flessibile con biadesivo 3M, 14,4 w/mt, cavo alimentazione rosso/nero cm 30.
Flexible strip Led, 14,4 w/mt, red/black cable cm 30.



ROLLA - 500 cm	Led
999030	1 4000°K
	6 3000°K
STRIP - 10 cm	8 2700°K
999039	

Code		W/mt	Led/mt	Lm/mt 4000°K	Lm/mt 3000°K	Lm/mt 2700°K
999030	5,1 cm - 7 Led	14,4	140	1947	1836	1712
999039						

IP 64 CRI90 - SDCM3 - SMD2835
24 Vdc Led - input current 0,6 A/MT
30.000h  -20° + 40° 
Led CRI90   IP 64 

Installare su superfici dissipanti il calore.
Applicazione: IP20 luoghi asciutti - IP64 luoghi asciutti e umidi.
Install only on dissipating surfaces.
Application IP20 dry places - IP64 dry and humid places.

Il codice 999049 - 999039 è riferito a 10 cm. Per definire la lunghezza della strip considerare la misura di taglio Led.
Code 999049-999039 is referred to 10cm. To define the final length consider the cut measure of the Led.

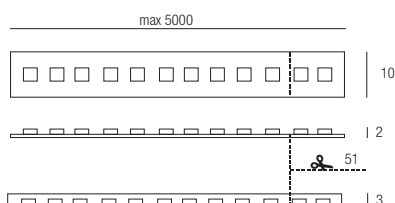





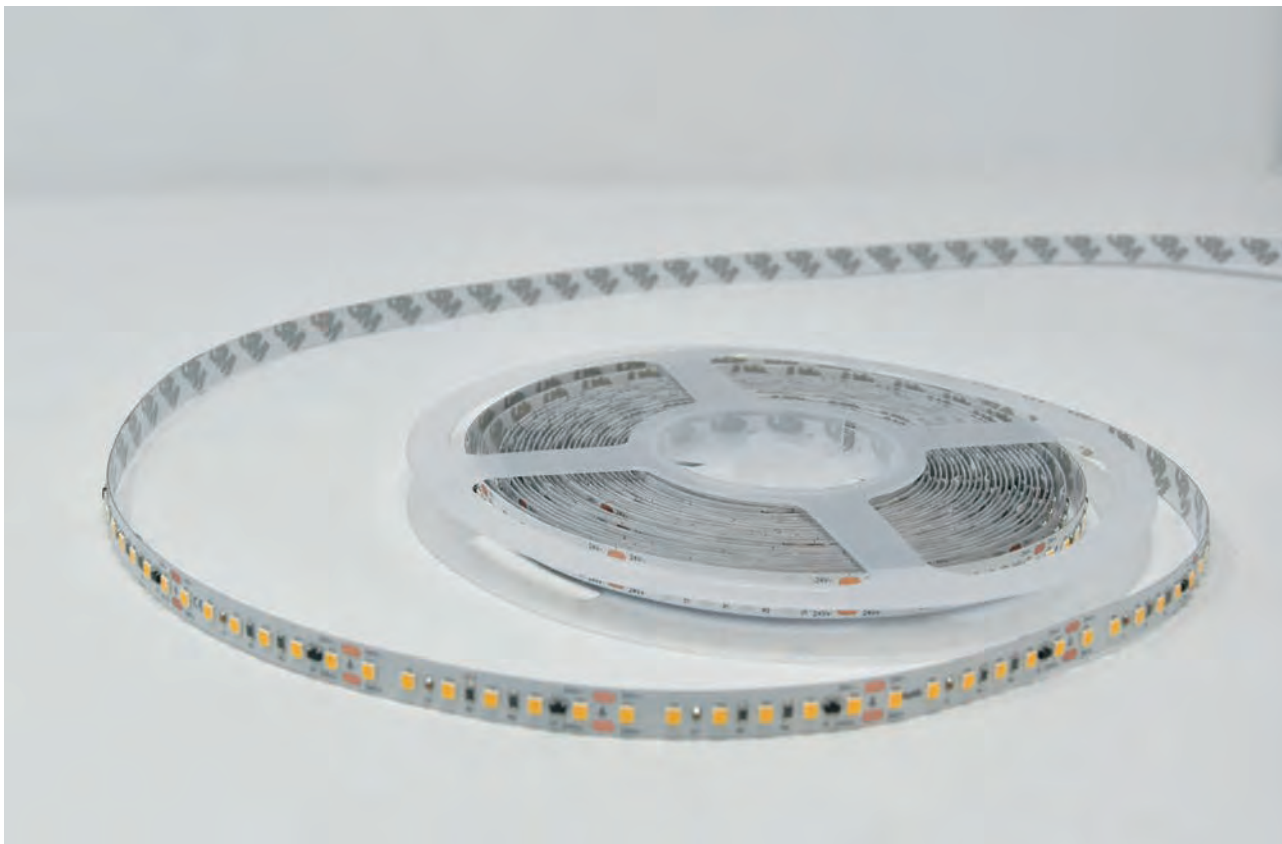

STRIP FLEX 14,4 W/MT 120 LED/MT - CRI 90 - IP 20

Strip Led flessibile con biadesivo 3M 14,4 w/mt, cavo alimentazione rosso/nero cm 30 - LUNGHEZZA 10 MT - **STRIP ALIMENTABILE FINO A 10 MT.**
 Flexible strip Led 14,4 w/mt, red/black cable cm 30 - length 10 mt.



ROLLA - 1000 cm	Led
999050	1 4000°K 6 3000°K 8 2700°K

Code		W/mt	Led/mt	Lm/mt 4000°K	Lm/mt 3000°K	Lm/mt 2700°K
999050	5 cm - 6 Led	14,4	120	1668	1573	1626

IP 20 CRI90 - SDCM3 - SMD2835
 24 Vdc Led - input current 0,6 A/MT
 30.000h  -20° + 40° 
 Led CRI90   IP 20 

Installare su superfici dissipanti il calore. Applicazione in luoghi asciutti in ambienti interni.
 Install only on dissipating surfaces. Application on a dry place indoors.

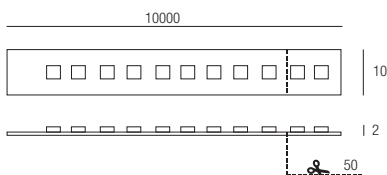

STRIP FLEX 9,6 W/MT 120 LED/MT - CRI 80 - IP 20

Strip Led flessibile con biadesivo 3M, 9,6 w/mt,cavo alimentazione rosso/nero cm 30.

Flexible strip Led, 9,6 w/mt, red/black cable cm 30.

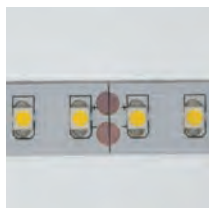

ROLLA - 500 cm	Led
9740	1 4000°-4500°K
	6 2800°-3000°K
STRIP - 10 cm	
9749	

Code		W/mt	Led/mt	Lm/mt 4000°K	Lm/mt 3000°K
9740	5 cm - 6 Led	9,6	120	887	837
9749					

IP 20 CRI80 - SDCM3 - SMD3528

24 Vdc Led - input current 0,4 A/MT

30.000h -20° + 40°

Led CRI80 IP 20

STRIP FLEX 9,6 W/MT 120 LED/MT - CRI 80 - IP 64

Strip Led flessibile con biadesivo 3M, 9,6 w/mt,cavo alimentazione rosso/nero cm 30.

Flexible strip Led, 9,6 w/mt, red/black cable cm 30.



ROLLA - 500 cm	Led
9730	1 4000°-4500°K
	6 2800°-3000°K
STRIP - 10 cm	
9739	

Code		W/mt	Led/mt	Lm/mt 4000°K	Lm/mt 3000°K
9730	5 cm - 6 Led	9,6	120	887	837
9739					

IP 64 CRI80 - SDCM3 - SMD3528

24 Vdc Led - input current 0,4 A/MT

30.000h -20° + 40°

Led CRI80 IP 64

Installare su superfici dissipanti il calore.

Applicazione: IP20 luoghi asciutti - IP64 luoghi asciutti e umidi.

Install only on dissipating surfaces.

Application IP20 dry places - IP64 dry and humid places.

Il codice 9749 - 9739 è riferito a 10 cm. Per definire la lunghezza della strip considerare la misura di taglio Led.

Code 9749-9739 is referred to 10cm. To define the final length consider the cut measure of the Led.

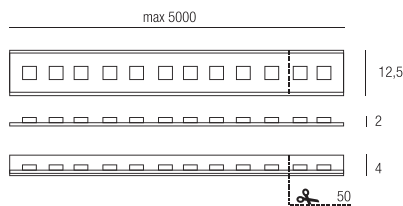

STRIP FLEX 4,8 W/MT 60 LED/MT - CRI 80 - IP 64

Strip Led flessibile con biadesivo 3M 4,8 w/mt, cavo alimentazione rosso/nero cm 30.
Flexible strip Led 4,8 w/mt, red/black cable cm 30.

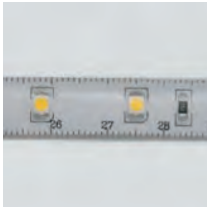

ROLLA - 500 cm	Led
970	1 4000°-4500°K
STRIP - 10 cm	6 2800°-3000°K
979	

Code		W/mt	Led/mt	Lm/mt 4000°K	Lm/mt 3000°K
970	10 cm - 6 Led	4,8	60	438	418
979					

IP 64 CRI80 - SDCM3

24 Vdc Led - input current 0,2 A/MT

30.000h -20° + 40°

Led CRI80 IP 64

max 5000

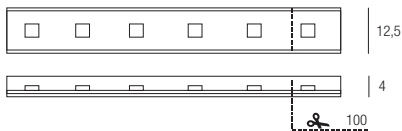

STRIP FLEX RGB 14,4 W/MT 60 LED/MT - CRI 80 - IP 20 - IP 64

Strip Led flessibile con biadesivo 3M 14,4 w/mt, cavo alimentazione rosso/nero cm 30.
Flexible strip Led 14,4 w/mt, red/black cable cm 30.



IP20	ROLLA - 500 cm	Led
	9910	9
	STRIP - 10 cm	
	9919	

IP64	ROLLA - 500 cm	Led
	990	9
	STRIP - 10 cm	
	999	

Code		W/mt	Led/mt
9910-9919	10 cm - 6 Led	14,4	60
990-999			

CRI80 - SDCM3 - SMD5050

24 Vdc Led - input current 0,6 A/MT

30.000h -20° + 40°

Led CRI80

max 5000

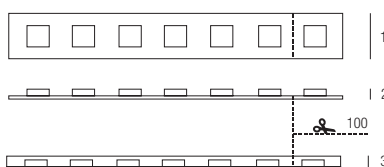

Installare su superfici dissipanti il calore.

Applicazione: IP20 luoghi asciutti - IP64 luoghi asciutti e umidi.

Install only on dissipating surfaces.

Application IP20 dry places - IP64 dry and humid places.

Il codice 9919 - 999 è riferito a 10 cm.

Per definire la lunghezza della strip considerare la misura di taglio Led.

Code 9919-999 is referred to 10cm. To define the final length consider the cut measure of the Led.

STRIP FLEX DYNAMIC WHITE 120 LED/MT - CRI 80 - IP 20

Strip Led flessibile con biadesivo 3M, regolazione colore da bianco freddo a bianco caldo.
Flexible strip Led, colour from cold to warm white.



Code		W/mt	Led/mt	Lm/mt
97900	5 cm - 6 Led	19,2	120	800
97990				

ROLLA - 500 cm **Led**

97900 Dynamic White
2800°-7000°K

STRIP - 10 cm

97990

IP 20 CRI80 - SDCM3

24 Vdc Led - input current 0,8 A/MT

 30.000h  -20° + 40° 

Led CRI80   IP 20 

STRIP FLEX RGB + WHITE 60 LED/MT - CRI 80 - IP 20

Strip Led flessibile con biadesivo 3M, cavo alimentazione rosso/nero cm 30.
Flexible strip Led, red/black cable cm 30.



Code		W/mt	Led/mt	White °K
97803	10 cm - 6 Led	19,2	60	2800-3300°
97893				

ROLLA - 500 cm **Led**

97803 RGB + White

STRIP - 10 cm

97893

IP 20 CRI80 - SDCM3

24 Vdc Led - input current 0,8 A/MT

 30.000h  -20° + 40° 

Led CRI80   IP 20 

Applicazione in luoghi asciutti in ambienti interni.
Application on a dry place indoors.

Il codice 97990 - 97893 è riferito a 10 cm. Per definire la lunghezza della strip considerare la misura di taglio Led.
Code 97990 - 97893 is referred to 10cm. To define the final length consider the cut measure of the Led.

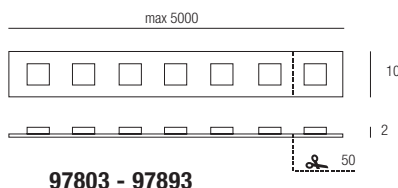
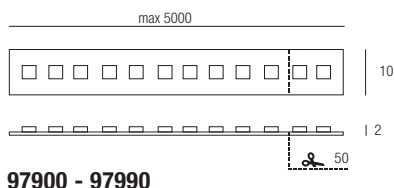

STRIP INGUAINATA IP 67

Strip Led flessibile inguainata IP67, cavo alimentazione FROR cm 100. Adatta per ambienti interni ed esterni.
 Sia la misura della strip inguainata che del cavo di alimentazione puo' essere fornita a richiesta con misure personalizzate fino ad un massimo di 5 m.
La strip inguainata IP67 è inseribile nei profili OMICRON – SIGMA – DELTA – SIHON – TAU – B LIGHT – MINI B LIGHT

Sheathed flexible strip Led IP67. FROR cable cm 100. Suitable for indoor and outdoor environments.
 Both the size of the sheathed strip and of the power cable can be supplied on request with customized measurements up to a maximum of 5 meters.
The sheathed strip IP67 can be inserted into the profiles OMICRON – SIGMA – DELTA – SIHON – TAU – B LIGHT – MINI B LIGHT



9,6 W/MT

Installare su superfici dissipanti il calore.
 Install only on dissipating surfaces.

STRIP - 10 cm	Led
996710	1 4000°K - 4500° 6 3000°K - 3300°

Code		W/mt	Led/mt	Lm/mt 4000°K	Lm/mt 3000°K
996710	5 cm - 6 Led	9,6	120	887	837

IP 67 CRI80 - SDCM3 - SMD3528
 24 Vdc Led - input current 0,4 A/MT
 30.000h -20° + 40°
 Led CRI80

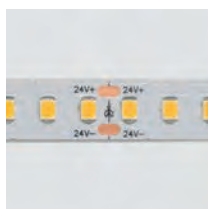
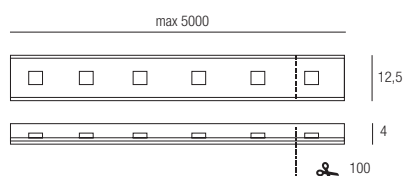

14,4 W/MT

Installare su superfici dissipanti il calore.
 Install only on dissipating surfaces.

STRIP - 10 cm	Led
996724	1 4000°K 6 3000°K 8 2700°K

Code		W/mt	Led/mt	Lm/mt 4000°K	Lm/mt 3000°K	Lm/mt 3000°K
996724	5,1 cm - 7 Led	14,4	140	1947	1836	1712

IP 67 CRI90 - SDCM3 - SMD2835
 24 Vdc Led - input current 0,6 A/MT
 30.000h -20° + 40°
 Led CRI90

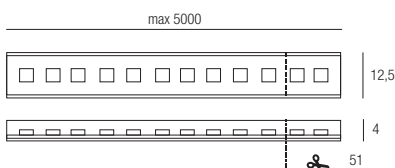

Il codice 996710- 996724 è riferito a 10 cm.
 Per definire la lunghezza della strip considerare la misura di taglio Led.
 Code 996710 - 996724 is referred to 10cm. To define the final length consider the cut measure of the Led.

SISTEMI

FOCUS 300

FOCUS 160

TWIN

sistemi

FOCUS 300

Design Athena

Focus 300 è un sistema a cavi 230V ideale per l'illuminazione di grandi spazi, uffici, show-room, negozi, ma utilizzabile anche in ambienti domestici come sale, cucine, corridoi. La vasta gamma degli accessori consente uno svariato utilizzo nella installazione del sistema, consentendo la tensione dello stesso in qualsiasi forma e di poter prendere l'alimentazione in qualsiasi punto del sistema.

L'apposito cavo a 2 conduttori consente inoltre sia l'accensione alternata che l'accensione simultanea dei corpi illuminanti, consentendo di alimentare gli stessi fino a 2500W per conduttore.

Focus 300 is a 230V cable system perfect for lighting large spaces, offices, show rooms and shops, but it can also be used in domestic environments such as lounges, kitchens and corridors. The vast range of accessories means the system can be installed in a variety of ways, making it possible to tension it in any shape and connect the electricity supply at any point in the system. The two-conductor cable supplied also makes it possible to switch the luminaires on alternately or simultaneously, meaning they can be supplied with up to 2500W per conductor.



Progetto realizzato presso Fondazione Ecomuseo Colli del Terzio

Sorgente Led
Led lighting source

INTERASSE 300 MM



SORGENTE LED
4x4W - 220/240V

Code	Color	Led
0289	5 White	1 4000°K - 1460 lm
	9 Black	6 3000°K - 1400 lm

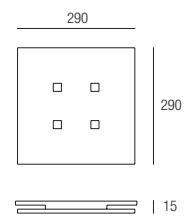

Led CRI >80 IP 40 840



Sorgente Led
Led lighting source

INTERASSE 300 MM



SORGENTE LED
12W - 220/240V

Code	Color	Led
0290	5 White	1 4000°K - 1550 lm
	7 Grey	6 3000°K - 1450 lm
	9 Black	

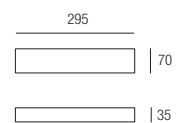

Led CRI >90 IP 40



Sorgente Led con pirex serigrafato/sabbiato
Led lighting source with printed/mat glass-screen

INTERASSE 300 MM



SORGENTE LED
220/240V

Code	Color	Lamp
0240	7 ■ Grey	R7S mm 117 Led max Ø 25

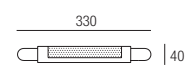

CE IP 40    



Faretto orientabile in metallo
Adjustable spotlight

INTERASSE 300 MM

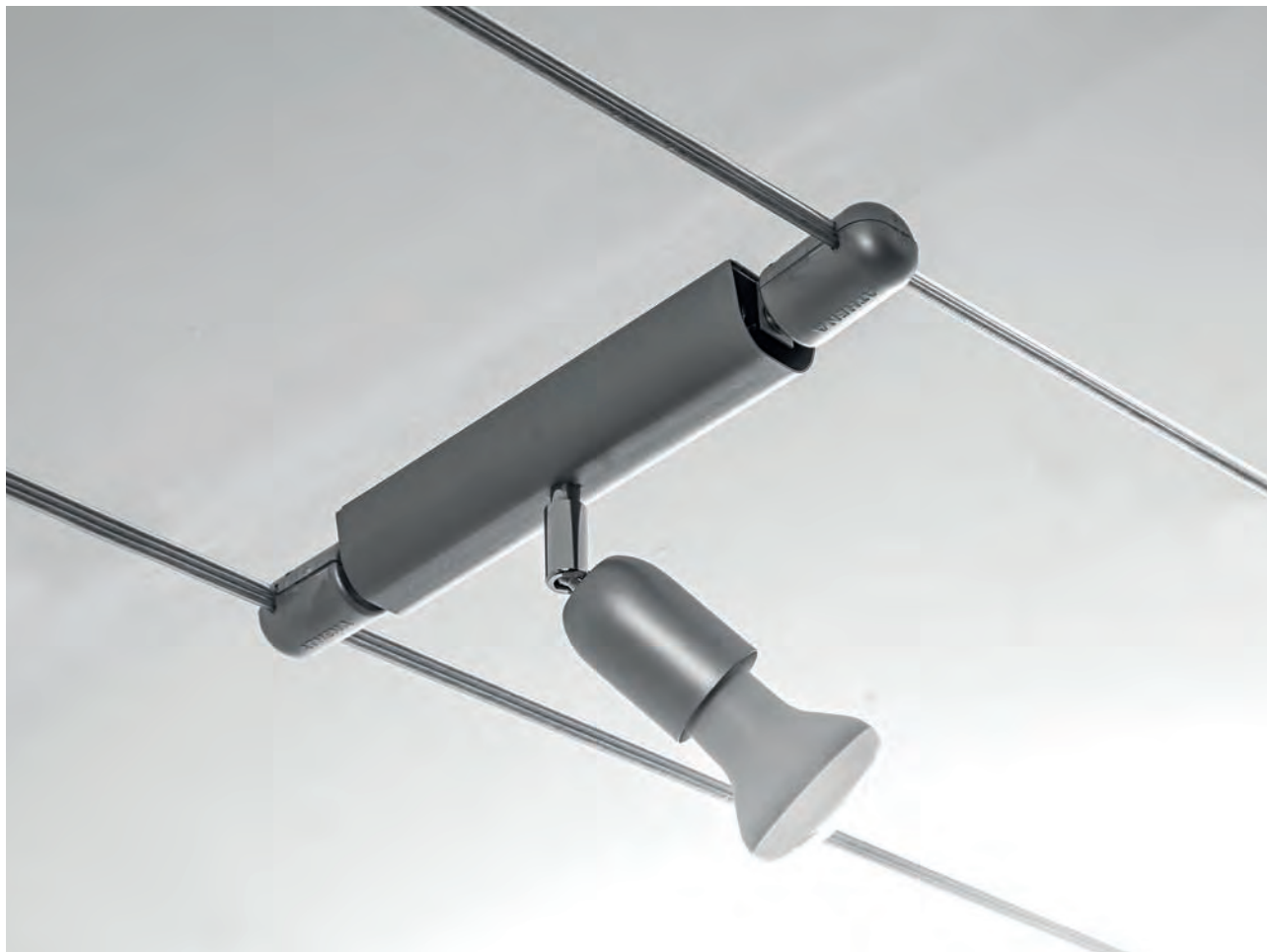

2 FARETTI ORIENTABILI
220/240V

Code	Color	Lamp
------	-------	------

0282	7 ■ Grey	E27 2 Led
------	----------	-----------

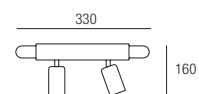

CE IP 20 490

1 FARETTO ORIENTABILE
220/240V

Code	Color	Lamp
------	-------	------

0272	7 ■ Grey	E27 1 Led
------	----------	-----------

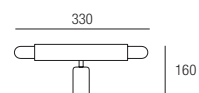

CE IP 20 380

Sorgente orientabile alogena o Led
Adjustable Led or Halo lighting source

INTERASSE 300 MM



2 FARETTI ORIENTABILI
220/240V

Code	Color	Lamp
0251	1 Chrome	GU10 2 Led GU10 2 AR 111 Led

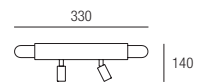

CE IP 20    460 

1 FARETTO ORIENTABILE
220/240V

Code	Color	Lamp
0234	1 Chrome	GU10 1 Led GU10 1 AR 111 Led

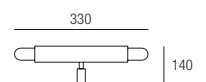

CE IP 20    380 

Sorgente orientabile Led
Adjustable Led lighting source

INTERASSE 300 MM



SORGENTE ORIENTABILE
220/240V

Code	Color	Lamp
0211	7 ■ Grey	GU10 AR 111 Led

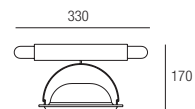

CE IP 20   
370

ACCESSORI FOCUS 300



CAVO

Cavo a due conduttori in rame e uno in acciaio per accensioni alternate
Idoneo per l'applicazione di apparecchi in classe II
2 copper connection cables and one steel cable to obtain alternated
lighting fitted for lamps CL II

Code

0200

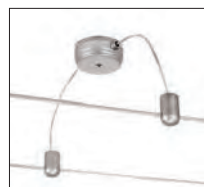

ALIMENTAZIONE

Alimentazione parete/soffitto applicabile in qualsiasi
punto del sistema (senza cavi)
Ceiling fitted leaders that can be applied to any
point of the system (without cables)

Code

Color

0202

7 ■ Grey



SOSTEGNO

Coppia sostegno cavi per tesate molto lunghe o quando vi siano
numerosi corpi lampade, H max 2000 mm
Twin support cables for long sections or with many lamps, H max 2000 mm

Code

Color

0203

1 ■ Chrome

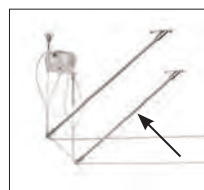

DISTANZIATORE

Distanziatore per tendere i cavi a soffitto in assenza di pareti, H max 300 mm
Distance piece for tightening cables to ceiling without walls, H max 300 mm

Code

Color

0204

1 ■ Chrome

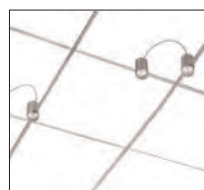

ALIMENTAZIONE

Coppia cavi alimentazione
Twin power supply cables

Code

Color

0205

7 ■ Grey



DEVIATORI

Coppia deviatori a parete
Wall deviation twin set

Code

Color

0206

7 ■ Grey



ANGOLARE

Supporto angolare parete 90°-120°
Angular wall support 90°-120°

Code

Color

0207

7 ■ Grey



**STAFFE**

Coppia staffa sostegno + rinforzo per staffa altezza massima 250 mm
Couple ceiling support bracket + reinforcements bracket max high 250 mm

Code	Color
------	-------

0208	1 ■ Chrome
-------------	------------

**TENDICAVO**

Kit tendicavo snodato composto da 4 tiranti e 4 isolanti - Interasse 300 mm
Jointed cable 4 tightening and 4 insulating - Distance 300 mm

Code	Color
------	-------

0209	1 ■ Chrome
-------------	------------

**TENDICAVO**

Kit tendicavo snodato composto da 4 tiranti, 2 isolanti e scatola per alimentazione elettrica - Interasse 300 mm
Jointed cable composed by 4 tightening, 2 insulating and electrical connectors - Distance 300 mm

Code	Color
------	-------

0210	7 ■ Grey
-------------	----------

**CURVA**

Kit per curve da 45° a 120° composto da staffa e rinforzo, H max 250 mm
Kit for a curve from 45° to 120° degrees, composed by bracket and reinforcement, H max 250 mm

Code	Color
------	-------

0214	1 ■ Chrome
-------------	------------



FOCUS 160

Design Athena

Il sistema a cavi Focus 160 può essere utilizzato in qualsiasi tipo di ambiente, sia lavorativo che domestico.

La vasta gamma di accessori e la versatilità del prodotto permettono di creare infinite varianti di sistemi, creando punti di luci in qualsiasi punto dell'ambiente in cui vengono collocati. Il cavo a 2 conduttori consente sia l'accensione alternata che l'accensione simultanea di tutti i corpi illuminanti. L'alimentazione può essere fatta in qualsiasi punto del sistema.

The cable system Focus 160 can be used in any type of locations, be it the workplace or home. The high variety of accessories and the versatility of the product give the possibility to create infinite variations of systems, creating light points in any point of the location in which they are placed. The 2-conductors cables permit the alternate turn on or the simultaneous turn on in all the enlightened bodies. Power supplies can be made in any part of the system.







Sorgente Led orientabile
Adjustable Led lighting source

INTERASSE 160 MM



SORGENTE LED
15W - 220/240V

Code	Color	Led	Polycarbonate
0457	5  White	1  4000°K - 1150 lm	1  Transparent
		6  3000°K - 1080 lm	

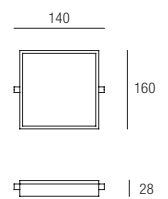

Led CRI >90  CE IP 40   

Sorgente Led orientabile
Adjustable Led source

INTERASSE 160 MM

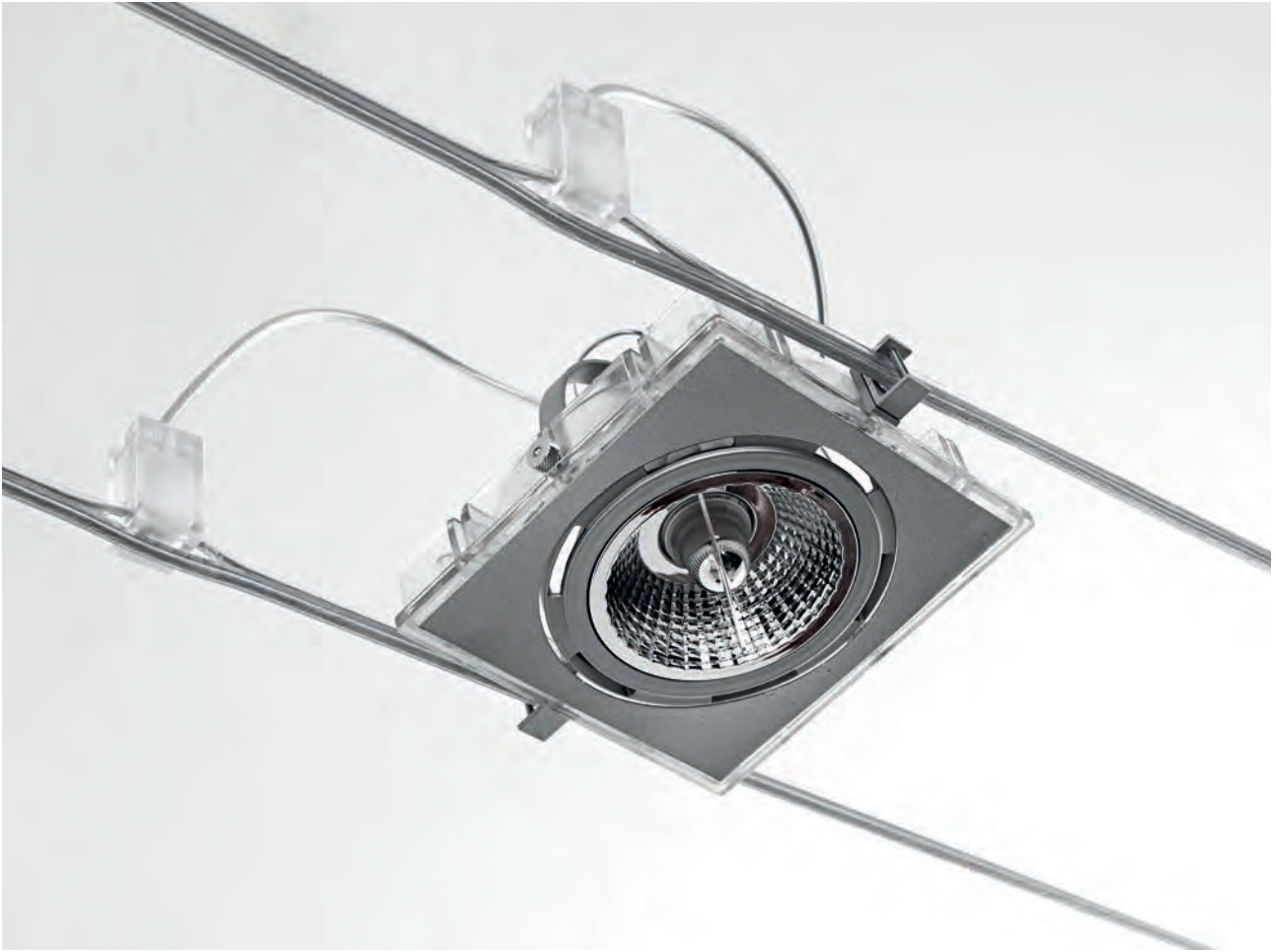

SORGENTE LED
220/240V

Code	Color	Led	Polycarbonate
0458	7 ■ Grey	GU10 AR 111 Led	1 □ Transparent

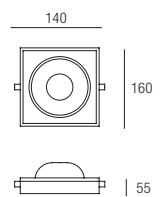

CE IP 20   
180

Sorgente Led orientabile
Adjustable Led source





INTERASSE 160 MM

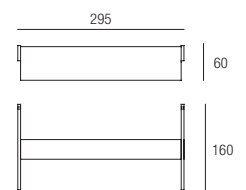

SORGENTE LED ORIENTABILE
12W - 220/240V

Code	Color	Led
0490	5 White	1 4000°K - 1550 lm
	7 Grey	6 3000°K - 1450 lm
	9 Black	



Led CRI >90   IP 40   
670

Faretti orientabili in metallo
Adjustable spotlight

INTERASSE 160 MM



FARETTO ORIENTABILE
220/240V

Code	Color	Lamp
0472	7 ■ Grey	E27 Led

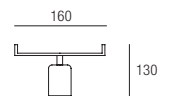

CE IP 20   
170

Sorgente Led orientabile
Adjustable Led source

INTERASSE 160 MM



1 FARETTO ORIENTABILE
220/240V

Code	Color	Lamp
0434	1 Chrome	GU10 1 Led GU10 1 AR 111 Led

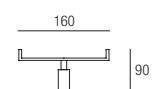

CE IP 20   
170

2 FARETTI ORIENTABILI
220/240V

Code	Color	Lamp
0435	1 Chrome	GU10 2 Led GU10 2 AR 111 Led

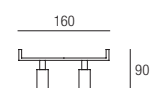

CE IP 20   
280

ACCESSORI FOCUS 160



CAVO

Cavo a due conduttori in rame e uno in acciaio per accensioni alternate
Idoneo per l'applicazione di apparecchi in classe II
2 copper connection cables and one steel cable to obtain alternated
lighting fitted for lamps CL II

Code

0200

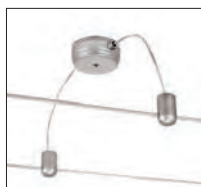

ALIMENTAZIONE

Alimentazione parete/soffitto applicabile in qualsiasi
punto del sistema (senza cavi)
Ceiling fitted leaders that can be applied to any
point of the system (without cables)

Code

Color

0202

7 ■ Grey



SOSTEGNO

Coppia sostegno cavi per tesate molto lunghe o quando vi siano
numerosi corpi lampade, H max 2000 mm
Twin support cables for long sections or with many lamps, H max 2000 mm

Code

Color

0203

1 ■ Chrome

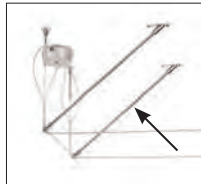

DISTANZIATORE

Distanziatore per tendere i cavi a soffitto in assenza di pareti, H max 300 mm
Distance piece for tightening cables to ceiling without walls, H max 300 mm

Code

Color

0204

1 ■ Chrome

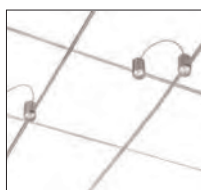

ALIMENTAZIONE

Coppia cavi alimentazione
Twin power supply cables

Code

Color

0205

7 ■ Grey



DEVIATORI

Coppia deviatori a parete
Wall deviation twin set

Code

Color

0206

7 ■ Grey



ANGOLARE

Supporto angolare parete 90°-120°
Angular wall support 90°-120°

Code

Color

0207

7 ■ Grey



**STAFFE**

Coppia staffa sostegno + rinforzo per staffa altezza massima 250 mm
 Couple ceiling support bracket + reinforcements bracket max high 250 mm

Code	Color
0208	1 Chrome
 343	

**TENDICAVO**

Kit tendicavo snodato composto da 4 tiranti e 4 isolanti - Interasse 160 mm
 Jointed cable 4 tightening and 4 insulating - Distance 160 mm

Code	Color
0209	1 Chrome
 310	

**TENDICAVO**

Kit tendicavo snodato composto da 4 tiranti, 2 isolanti e scatola per alimentazione elettrica - Interasse 160 mm
 Jointed cable composed by 4 tightening, 2 insulating and electrical connectors - Distance 160 mm

Code	Color
0210	7 Grey
 470	

**CURVA**

Kit per curve da 45° a 120° composto da staffa e rinforzo, H max 250 mm
 Kit for a curve from 45° to 120° degrees, composed by bracket and reinforcement, H max 250 mm

Code	Color
0214	1 Chrome
 450	

TWIN

Design Athena

INTERASSE 135 MM CON FARETTI CON ADATTATORE.
INTERASSE DISTANZA MAX 5000 MM CON SOSPENSIONI VETRO.

Twin è un sistema a 12 Vdc tensione costante. Sviluppato su un doppio cavo elettrificato. Risulta adatto per ogni soluzione illuminotecnica che voglia essere allo stesso tempo pratica, semplice nell'installazione, elegante e di grande effetto.

Data l'essenzialità delle sue linee risulta ottimale per ogni ambiente, che sia un'abitazione, uno show-room o un luogo più sobrio quale potrebbe essere un museo o una galleria d'arte. Con l'ampia gamma di sorgenti luminose e di componenti, la struttura ottiene il massimo della flessibilità.

Alla versatilità del sistema è affiancato inoltre un elevato standard qualitativo raggiunto basandone lo sviluppo sulle caratteristiche principali della nostra produzione: estetica, sicurezza e praticità. Si consiglia di restare entro una linea continua di max 8 m. alimentata da alimentatori a tensione costante.

Twin is a 12 Vdc constant voltage system. Based on an electrified double cable it is suitable for any technical lighting solution that needs to be practical, easy to install, elegant and of great effect. Thanks to its clean lines it is suitable for any environment, whether it may be a home, showroom or a more austere setting such as a museum or art gallery.

The structure offers great flexibility thanks to the wide range of light sources and components available.

Alongside its versatility, the system also boasts a high standard of quality obtained by basing its development on the main features of our production range: appearance, safety and practicality. We recommend staying within a maximum continuous line of 8 metres with power supplied with a constant tension DRIVERS.



Sorgente Led orientabile
Adjustable Led lighting source

INTERASSE 135 MM



FARETTO ORIENTABILE LED
5,8W - 12Vdc

Code	Color	Led	Polycarbonate
0357	1 Chrome	1 4000°K - 920 lm 6 3000°K - 848 lm	1 Transparent

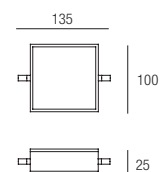

Led CRI >80 IP 40 212



Sorgente Led orientabile
Adjustable Led lighting source

INTERASSE 135 MM



FARETTO ORIENTABILE LED
5,8W - 12Vdc

Code	Color	Led
0358	5 White	1 4000°K - 920 lm 6 3000°K - 848 lm

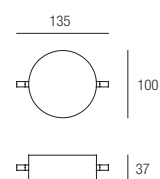



Led CRI >80   IP 40   

Sorgente Led
Led source

INTERASSE 135 MM



SORGENTE LED
5,8W - 12Vdc

Code	Color	Led
0360	5  White	1  4000°K - 920 lm
		6  3000°K - 848 lm

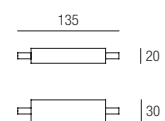



Led CRI >80  CE IP 40   115

Sorgente Led
Led source

INTERASSE 135 MM



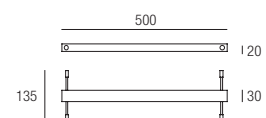

SORGENTE LED
10W - 12Vdc

Code	Color	Led
0361	5  White	1  4000°K - 758 lm
		6  3000°K - 739 lm



Led CRI >90  CE IP 40   
515

SORGENTE LED
19W - 12Vdc

Code	Color	Led
0362	5  White	1  4000°K - 1548 lm
		6  3000°K - 1509 lm

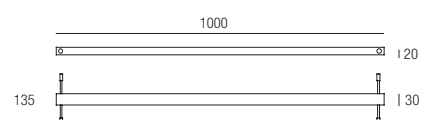

Led CRI >90  CE IP 40   
840



Sospensione Led
Led suspension



SORGENTE LED
5,8W - 12Vdc

Code	Color	Led
0363	5 White	1 4000°K - 920 lm 6 3000°K - 848 lm

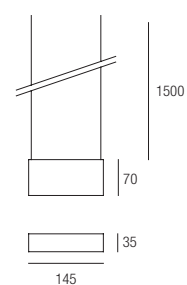

Led CRI >80 IP 40

Sorgenti Led
Led lighting sources



FARETTO ORIENTABILE
12Vdc

Code	Color	Lamp
0353	1 Chrome	G5,3 Led

250

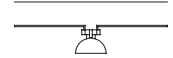

CE IP 20   

36

Sorgenti Led
Led lighting sources



FARETTO
12Vdc

Code	Color	Lamp
0355	1 Chrome	G4 Led G6,35 Led



CE IP 20   
24



Sorgenti Led
Led lighting sources



FARETTO ORIENTABILE
12Vdc

Code	Color	Lamp
0354	1  Chrome	G5,3 Led

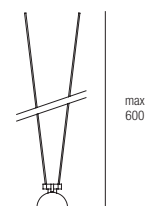

CE IP 20   55

Sorgenti Led
Led lighting sources



FARETTO ORIENTABILE
12Vdc

Code	Color	Lamp
3110	1 Chrome	G5,3 Led

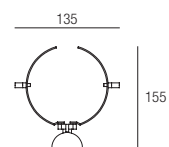

CE IP 20   

Sorgenti Led
Led lighting sources



FARETTO ORIENTABILE
12Vdc

Code	Color	Lamp
3310	1 Chrome	G5,3 Led

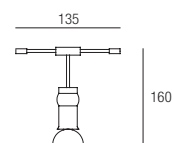

CE IP 20   
150



Sorgenti Led
Led lighting sources



FARETTI ORIENTABILI
12Vdc

Code	Color	Lamp
1410	7 ■ Grey	G53 AR 111 Led

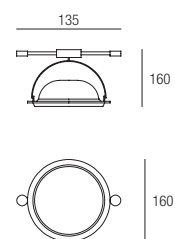

CE IP 20    



Sospensione con cavo mm 6000 - Interasse max mm 5000
 Suspensions with cable mm 6000 - Interaxis distance mm 5000



Code	Cable	Color	Glass	Lamp
0647	1 x cm 600	1 Chrome	1 Clear	G4 12 Vdc Led
064715	2 x cm 150		3 Pink gold	G5,3 12 Vdc Led
			9 Black chrome	G6,35 12 Vdc Led

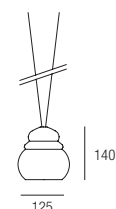
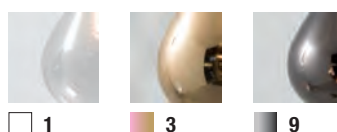

CE IP 20 240



Code	Cable	Color	Glass	Lamp
0648	1 x cm 600	1 Chrome	1 Clear	G4 12 Vdc Led
064815	2 x cm 150		3 Pink gold	G5,3 12 Vdc Led
			9 Black chrome	G6,35 12 Vdc Led

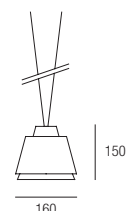
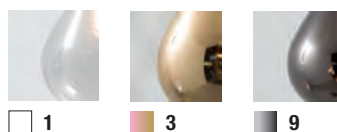

CE IP 20 370



Code	Cable	Color	Glass	Lamp
0631	1 x cm 600	1 Chrome	1 Clear	G4 12 Vdc Led
063115	2 x cm 150			G6,35 12 Vdc Led

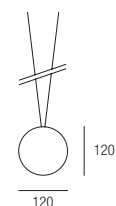

CE IP 20 240

Sospensione con cavo mm 6000 - Interasse max mm 5000
 Suspensions with cable mm 6000 - Interaxis distance mm 5000



Code	Cable	Color	Glass	Lamp
0635	1 x cm 600	1 Chrome	1 Clear	G4 12 Vdc Led
063515	2 x cm 150		3 Pink gold	G6,35 12 Vdc Led
			9 Black chrome	

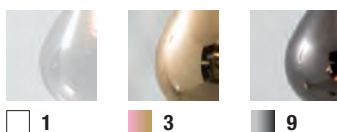
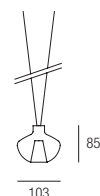

CE IP 20 165



Code	Cable	Color	Glass	Lamp
0644	1 x cm 600	1 Chrome	1 Clear	G4 12 Vdc Led
064415	2 x cm 150		3 Pink gold	G6,35 12 Vdc Led
			9 Black chrome	

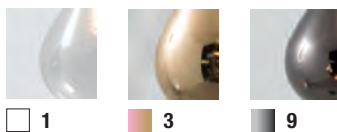
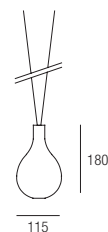

CE IP 20 205



Code	Cable	Color	Glass	Lamp
0646	1 x cm 600	1 Chrome	1 Satin	G4 12 Vdc Led
064615	2 x cm 150			G6,35 12 Vdc Led

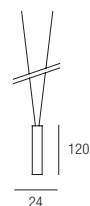

CE IP 20 120

Sospensione con cavo mm 6000 - Interasse max mm 5000
 Suspensions with cable mm 6000 - Interaxis distance mm 5000



Code	Cable	Color	Glass	Lamp
0649	1 x cm 600	1 Chrome	1 Clear	G4 12 Vdc Led
064915	2 x cm 150		3 Pink gold	G6,35 12 Vdc Led
			9 Black chrome	

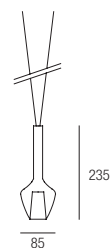
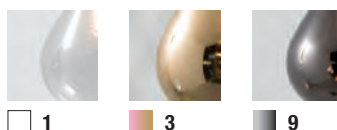

CE IP 20 250



Code	Cable	Color	Glass	Lamp
0639	1 x cm 600	1 Chrome	1 Satin	G4 12 Vdc Led
063915	2 x cm 150			G5,3 12 Vdc Led
				G6,35 12 Vdc Led

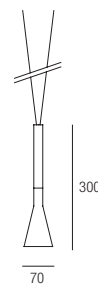

CE IP 20 235



Code	Cable	Color	Glass	Lamp
0640	1 x cm 600	1 Chrome	1 Satin	G4 12 Vdc Led
064015	2 x cm 150			G5,3 12 Vdc Led
				G6,35 12 Vdc Led

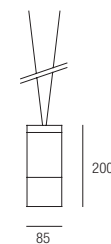

CE IP 20 370

ACCESSORI TWIN



COPPIA SOSTEGNO CAVI

Coppia sostegno cavi per tesate molto lunghe o quando vi siano numerosi corpi lampade, H max 2000 mm
Twin support cables for long sections or with many lamps, H max 2000 mm

Code **Color**

0203 **1** Chrome



168



STAFFE

Coppia staffa sostegno
+ coppia rinforzo per staffa H max 250 mm
Pair of support bracket
+ pair of reinforcement brackets H max 250 mm

Code **Color**

0208 **1** Chrome



343



ALIMENTAZIONE

Coppia alimentazione (cavi non forniti)
Couple of power accessories (without cable)

Code **Color**

0328 **1** Chrome



33



CAVO RAME NON ISOLATO

Cavo rame non isolato mmq. 6 - 30A
Copper cable not insulated mmq. 6 - 30A

Code

0319



55



CAVO RAME ISOLATO

Cavo rame isolato mmq. 6 - 25A
Copper cable insulated mmq. 6 - 25A

Code

0329



55



TENDICAVO

Kit tendicavo snodato - 4 tiranti
Jointed cable tightening kit

Code **Color**

0330 **1** Chrome



284



STAFFE

Coppia staffa sostegno H 250 mm
Pair of ceiling support brackets H 250 mm

Code **Color**

0331 **1** Chrome

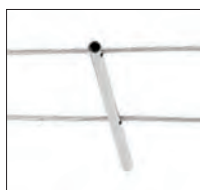

308

**STAFFA**

Staffa sostegno a parete H 250 mm
Wall support bracket H 250 mm

Code	Color
------	-------

0335	1 Chrome
-------------	--

**KIT PER CURVE**

Kit per curve da 45° a 120° + staffa + rinforzo H max 250 mm
Kit for a curve from 45° to 120° + brackets + reinforcement H max 250 mm

Code	Color
------	-------

0336	1 Chrome
-------------	--

**KIT PER CURVA**

Kit per curva regolabile parete/soffitto
Couple of wall/ceiling adjustable curve

Code	Color
------	-------

0338	1 Chrome
-------------	--

**STAFFE**

Coppia staffa sostegno H 95 mm
Pair of ceiling support brackets H 95 mm

Code	Color
------	-------

0340	1 Chrome
-------------	--

**STAFFE**

Coppia staffa sostegno H 95 mm
Pair of ceiling support brackets H 95 mm

Code	Color
------	-------

0341	1 Chrome
-------------	--



Contenitore in metallo con alimentatore 230/12Vdc completo di coppia di alimentazione per Led.
Box with driver 230/12Vdc with feed supply couple for Led.



Ø 220x45

Code	Glass	Watt
1289	5 White	75 W 12Vdc

CE IP 20 1020

Ø 220x45

Code	Glass	Watt
1290	5 White	150 W 12Vdc

CE IP 20 1100



180x140x40

Code	Glass	Watt
1291	5 White	75 W 12Vdc

CE IP 20 670

230x127x52

Code	Glass	Watt
1292	5 White	150 W 12Vdc

CE IP 20 1010

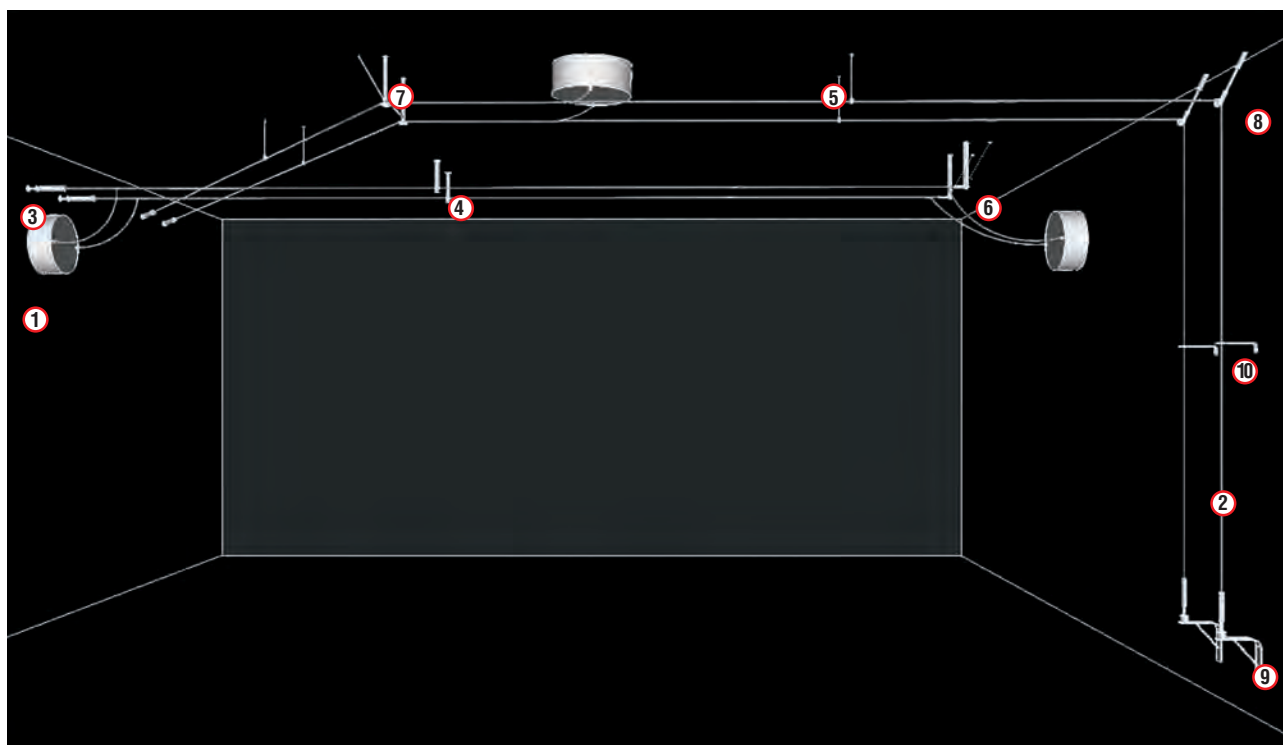

① **1289** **1290** **1291** **1292**

Contenitore con alimentatore.
Box with power supply.

⑤ **0203 1** cromo

Staffa sostegno cavi.
Twin support cables.

⑨ **0340**

Coppia staffa sostegno.
Pair of ceiling support brackets.

② **0329** **0319**

Cavo rame.
Copper cable.

⑥ **0208 1** cromo

Coppia staffa sostegno.
Couple support bracket.

⑩ **0341**

Coppia staffa sostegno.
Pair of ceiling support brackets.

③ **0330 1** cromo

Kit tendicavo.
Jointed cable tightening kit.

⑦ **0336 1** cromo

Kit per curva 45° a 120°.
Kit for a curve from 45° to 120°.

④ **0331 1** cromo

Staffa sostegno soffitto.
Ceiling support brackets.

⑧ **0338 1** cromo

Curva regolabile.
Adjustable curve.

DECORATIVO

TAG
SWING
ATLAS
LIBRO
MODÌ
OMICRON
SLASH
INCROCIO
EDERA
ALVIN
DADAJE
GIOTTO
DEGAS
MONET
PICASSO
BETA

Decorativo

TAG

Design Athena

Serie di plafoniere, sospensioni ed applique disponibili nelle finiture oro, corten, bianco, nero, grigio e ardesia. Alimentatore incluso.

Collection of ceiling, suspension and wall lamps available in gold, white, black, grey and dark grey finishes. Driver included.





APPLIQUE / PLAFONE LED 32W 220/240V

Code	Color	Led
8021	3 Gold	1 4000°K - 4893 lm
	4 Corten	6 3000°K - 4615 lm
	5 White	8 2700°K - 4305 lm
	6 Ardesia	
	7 Grey	
	9 Black	

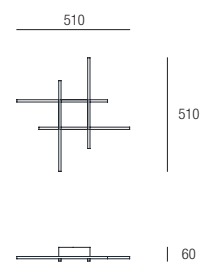

Led CRI >90 IP 40 890

APPLIQUE / PLAFONE LED 50W 220/240V

Code	Color	Led
8022	3 Gold	1 4000°K - 7562 lm
	4 Corten	6 3000°K - 7132 lm
	5 White	8 2700°K - 6655 lm
	6 Ardesia	
	7 Grey	
	9 Black	

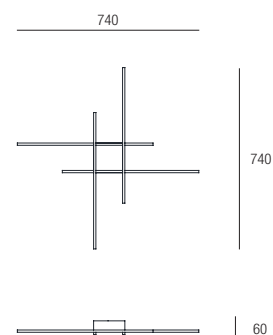

Led CRI >90 IP 40 950



APPLIQUE / PLAFONE LED 63W 220/240V

Code	Color	Led
8023	3 Gold	1 4000°K - 9786 lm
	4 Corten	6 3000°K - 9230 lm
	5 White	8 2700°K - 8610 lm
	6 Ardesia	
	7 Grey	
	9 Black	

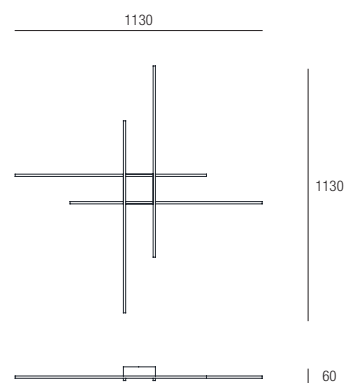

Led CRI >90 IP 40 1100

APPLIQUE / PLAFONE LED 48W 220/240V

Code	Color	Led
8024	3 Gold	1 4000°K - 7342 lm
	4 Corten	6 3000°K - 6920 lm
	5 White	8 2700°K - 6460 lm
	6 Ardesia	
	7 Grey	
	9 Black	

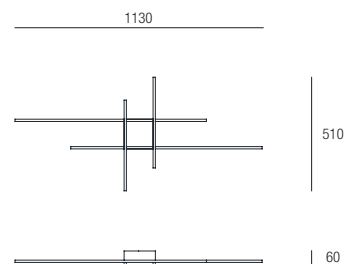

Led CRI >90 IP 40 1000





APPLIQUE / PLAFONE LED 19W 220/240V

Code	Color	Led
8025	3 Gold	1 4000°K - 2864 lm
	4 Corten	6 3000°K - 2702 lm
	5 White	8 2700°K - 2520 lm
	6 Ardesia	
	7 Grey	
	9 Black	

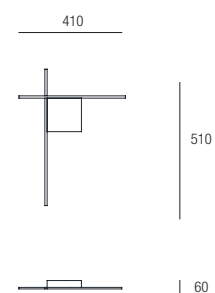

Led CRI >90 IP 40 750

APPLIQUE / PLAFONE LED 30W 220/240V

Code	Color	Led
8026	3 Gold	1 4000°K - 4733 lm
	4 Corten	6 3000°K - 4464 lm
	5 White	8 2700°K - 4165 lm
	6 Ardesia	
	7 Grey	
	9 Black	

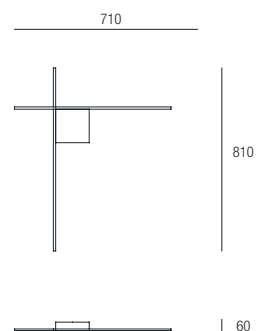

Led CRI >90 IP 40 800

SOSPENSIONE LED 67W 220/240V

Code	Color	Led
8051	3 Gold	1 4000°K - UP 444 lm DOWN 9780 lm
	4 Corten	6 3000°K - UP 418 lm DOWN 9200 lm
	5 White	8 2700°K - UP 390 lm DOWN 8600 lm
	6 Ardesia	
	7 Grey	
	9 Black	

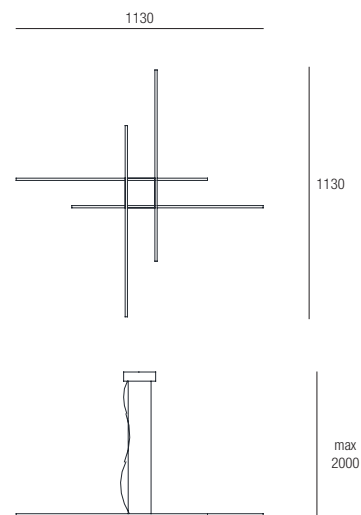

Led CRI >90   IP 40       1200

SOSPENSIONE LED 61W 220/240V

Code	Color	Led
8052	3 Gold	1 4000°K - UP 444 lm DOWN 8672 lm
	4 Corten	6 3000°K - UP 418 lm DOWN 8160 lm
	5 White	8 2700°K - UP 390 lm DOWN 7620 lm
	6 Ardesia	
	7 Grey	
	9 Black	

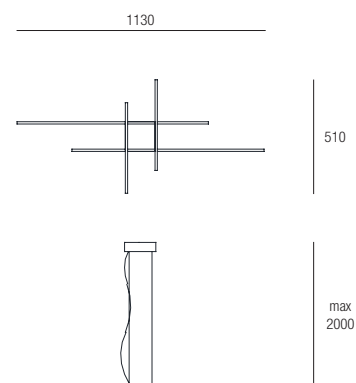

Led CRI >90   IP 40       1100



SWING

Design Athena

Collezione di plafoniere e applique disponibili nelle finiture oro, corten, bianco, ardesia, grigio e nero. I bracci delle lampade sono orientabili a 360°.
A richiesta le plafoniere possono essere dimmerate tramite l'accessorio 1298.

Ceiling and wall lights available in gold, corten, white, dark grey, grey and black finishes. The arms of the lamps are adjustable at 360°.
Upon request, the light could be adjusted thanks to the 1298 accessory.





PLAFONIERA LED 30W 220/240V

Code	Color	Led
812120	3 Gold	1 4000°K - 4670 lm
	4 Corten	6 3000°K - 4400 lm
	5 White	8 2700°K - 4100 lm
	6 Ardesia	
	7 Grey	
	9 Black	

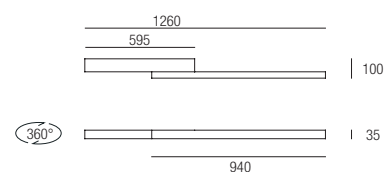

Led CRI >90 E CE IP 40 V ⚡ R GR 1350

PLAFONIERA LED 48,5W 220/240V

Code	Color	Led
812320	3 Gold	1 4000°K - 7448 lm
	4 Corten	6 3000°K - 7000 lm
	5 White	8 2700°K - 6450 lm
	6 Ardesia	
	7 Grey	
	9 Black	

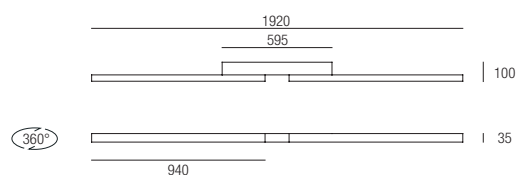

Led CRI >90 E CE IP 40 V ⚡ R GR 1600



APPLIQUE LED 13W 220/240V

Code	Color	Led
816120	3 Gold	1 4000°K - 2000 lm
	4 Corten	6 3000°K - 1888 lm
	5 White	8 2700°K - 1760 lm
	6 Ardesia	
	7 Grey	
	9 Black	

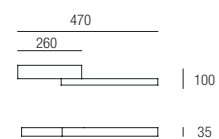

Led CRI >90 **A** CE IP 40



ATLAS

Design Athena

Serie di apparecchi tondi o quadrati di varie dimensioni ad illuminazione indiretta che possono essere installati sia a parete che a plafone. Disponibile nelle finiture gold, bianco, nero, ardesia e grigio. Gli apparecchi possono essere combinati tra di loro e sovrapposti tramite distanziali. Alimentatori a ordinare separatamente e da inserire nell'apparecchio. Completano la collezione i modelli ATLAS DECÒ.

Collection of round or square indirect lightning appliances of various dimensions which they can be installed on the wall or on the ceiling. They are available in golden, white, black, dark grey and grey finishes. The appliances can be combined and/or overlaid thank to spacers. The power supply is to be ordered separately and to be inserted in the appliance.



APPLIQUE / PLAFONE 220 LED 9,5W

Code	Color	Led
○ 7821	3 Gold	1 4000°K - 1463 lm
□ 7822	5 White	6 3000°K - 1380 lm
○ 7823	6 Ardesia	8 2700°K - 1280 lm
	7 Grey	
	9 Black	

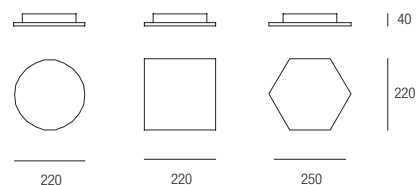

APPLIQUE / PLAFONE DECÒ 220 LED 9,5W

Code	Color	Led
○ 7821D	3 Gold Decò	1 4000°K - 1463 lm
□ 7822D	5 White Decò	6 3000°K - 1380 lm
○ 7823D	8 Octane Decò	8 2700°K - 1280 lm
	9 Black Decò	

7821 7821D	7822 7822D	7823 7823D
450	520	480

Led CRI >90 IP 20

Se utilizzato singolo (non in composizione) l'alimentatore utilizzabile è solo il modello 1183 (non dimmerabile)

Alimentatori e dimmer pag 194

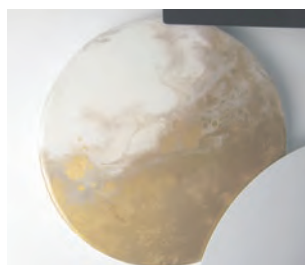

3 Gold Decò

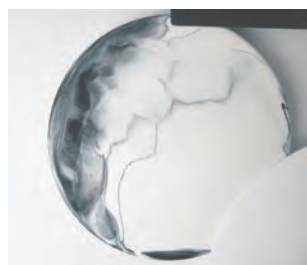

5 White Decò



8 Octane Decò

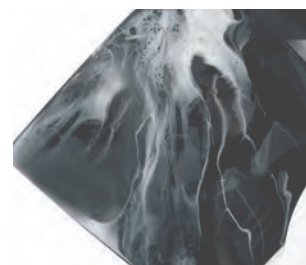

9 Black Decò

I modelli della collezione **Atlas Decò** vengono realizzati da maestri artigiani esperti nell'utilizzo e nella decorazione su resina. Eventuali imperfezioni sulla superficie come puntini prodotti dalla lavorazione artigianale del pezzo oppure una superficie non completamente livellata non devono essere interpretati come difetti di produzione, ma sono garanzia di una lavorazione artigianale della resina che viene fatta completamente a mano.

Le foto sono solo indicative del prodotto. Essendo ogni pezzo eseguito artigianalmente la decorazione varia su ciascun pezzo e ne assicura l'unicità.

The models of the Atlas Decò collection are made by master artisans who are expert in the use and decoration of resins.

Any imperfection on the surface such as dots created during the working of the item or a not completely levelled surface shouldn't be considered as production defects; they are indeed a guarantee of the completely hand-made artisan working.

Photos are an indication of the product, given that it's hand-made the decorations vary for each item and this assures their uniqueness.

APPLIQUE / PLAFONE 300 LED 13W

Code	Color	Led
○ 7824	3 Gold	1 4000°K - 2000 lm
□ 7825	5 White	6 3000°K - 1888 lm
○ 7826	6 Ardesia	8 2700°K - 1822 lm
	7 Grey	
	9 Black	

7824 7824D	7825 7825D	7826 7826D
		
1100	1300	1150

APPLIQUE / PLAFONE DECÒ 300 LED 13W

Code	Color	Led
○ 7824D	3 Gold Decò	1 4000°K - 2000 lm
□ 7825D	5 White Decò	6 3000°K - 1888 lm
○ 7826D	8 Octane Decò	8 2700°K - 1822 lm
	9 Black Decò	

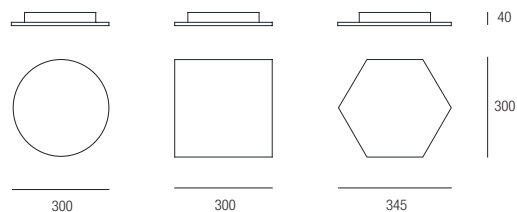

Led CRI >90   IP 20   

APPLIQUE / PLAFONE 400 LED 20W

Code	Color	Led
○ 7827	3 Gold	1 4000°K - 3000 lm
□ 7828	5 White	6 3000°K - 2830 lm
○ 7829	6 Ardesia	8 2700°K - 2640 lm
	7 Grey	
	9 Black	

7827 7827D	7828 7828D	7829 7829D
		
1650	2000	1850

APPLIQUE / PLAFONE DECÒ 400 LED 20W

Code	Color	Led
○ 7827D	3 Gold Decò	1 4000°K - 3000 lm
□ 7828D	5 White Decò	6 3000°K - 2830 lm
○ 7829D	8 Octane Decò	8 2700°K - 2640 lm
	9 Black Decò	

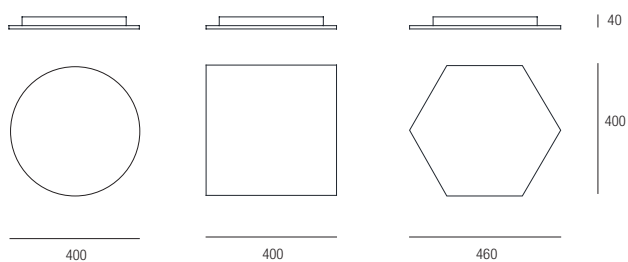

Led CRI >90   IP 20   

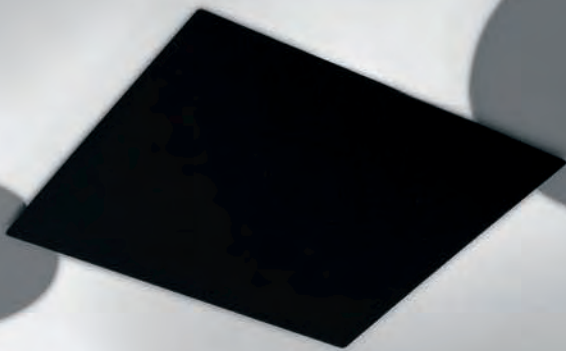

dream

APPLIQUE / PLAFONE 500 LED 26W

Code	Color	Led
○ 7830	3 Gold	1 4000°K - 3890 lm
□ 7831	5 White	6 3000°K - 3670 lm
○ 7832	6 Ardesia	8 2700°K - 3420 lm
	7 Grey	
	9 Black	

7830 7830D	7831 7831D	7832 7832D
 2400	 2850	 2700

APPLIQUE / PLAFONE DECÒ 500 LED 26W

Code	Color	Led
○ 7830D	3 Gold Decò	1 4000°K - 3890 lm
□ 7831D	5 White Decò	6 3000°K - 3670 lm
○ 7832D	8 Octane Decò	8 2700°K - 3420 lm
	9 Black Decò	

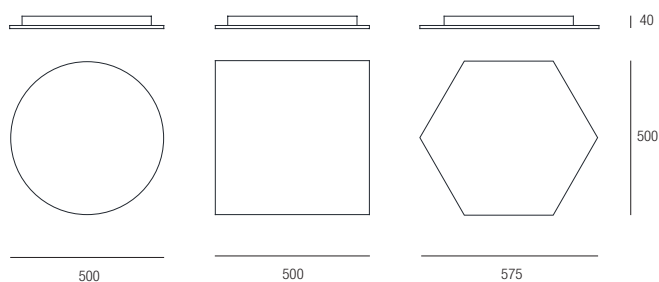

Led CRI >90   IP 20   

ACCESSORI - - DISTANZIALE PER SOVRAPPOSIZIONE

Code	Color	Distanziale X
7892	5 White	Atlas 300
7893		Atlas 400
7894		Atlas 500

7892	7893	7894
 100	 150	 200





ALIMENTATORI inseribili nelle plafoniere
DRIVERS to insert into ceiling lamps

Code		
1183	max 20W	24Vdc Non dimmerabile
1169	max 50W	24Vdc
1184	max 75W	24Vdc
1182	max 100W	24Vdc
1185	max 150W	24Vdc (solo per diametro 40 e 50 cm)

CENTRALINE PER DIMMERAZIONE inseribili nelle plafoniere
DIMMABLE DRIVERS to insert into ceiling lamps

Code		
1260	max 240W	DALI - 0-10V - PUSH
1306	max 240W	PUSH
1308	max 240W	RF - PUSH+TELECOMANDO 4 zone
1309	max 240W	RF - PUSH+TELECOMANDO wireless
1311	max 240W	RF - PUSH (2CH) - APP TUYA - ALEXA - AMAZON ECHO



LIBRO

Design Athena





Applique verniciata bianco, corten, ardesia e nero. Disponibile in 4 versioni adattabili all'illuminazione di vari ambienti.
White, corten, dark grey and black wall lamp. Available in 4 versions that make it suitable for the illumination in many locations.









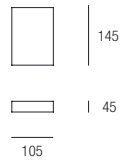

APPLIQUE 1 X GX53 220/240V

Code	Color	Lamp
8671	4  Corten	1 x GX53 Led
	5  White	
	6  Ardesia	
	9  Black	



CE IP 20   



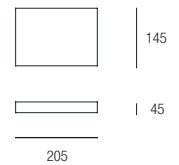

APPLIQUE 2 X GX53 220/240V

Code	Color	Lamp
8672	4  Corten	2 x GX53 Led
	5  White	
	6  Ardesia	
	9  Black	



CE IP 20   



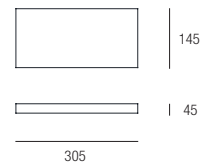

APPLIQUE 3 X GX53 220/240V

Code	Color	Lamp
8673	4  Corten	3 x GX53 Led
	5  White	
	6  Ardesia	
	9  Black	



CE IP 20   

APPLIQUE 4 X GX53 220/240V

Code	Color	Lamp
8674	4  Corten	4 x GX53 Led
	5  White	
	6  Ardesia	
	9  Black	

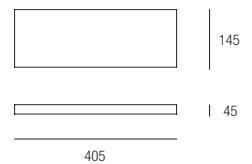

CE IP 20   

MODÌ

Design Athena

Appliche e piantana verniciati bianco, nero e ardesia. Nonostante le dimensioni contenute gli apparecchi montano un Led da 30W che sviluppa 2840 o 2700 lumen e li rendono adatti all'illuminazione di vari ambienti.

Led applique and floor lamp painted white, black and dark grey. Even though it has small dimensions, the device supports a 30W Led which develops 2840 o 2700 lumen and which will make it suitable for the illumination in many locations.



APPLIQUE LED

Sorgente Led 30W - 220/240v dimmerabile

Code	Color	Led
8661	5 White	1 4000°K - 2840 lm
	6 Ardesia	6 3000°K - 2700 lm
	9 Black	

200



135

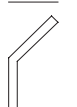

220



Led CRI >90 IP 20 850

PIANTANA LED

Led 30W - 220/240v dimmerabile

Code	Color	Led
8680	5 White (cavo tessuto bianco)	1 4000°K - 2840 lm
	6 Ardesia (cavo tessuto nero)	6 3000°K - 2700 lm
	9 Black (cavo tessuto nero)	

135



240



1900

Cavo colorato rosso a richiesta
Red cable on demand

Led CRI >90 IP 20 7800



OMICRON

Design Athena

Plafoniere, sospensioni e applique LED realizzate in alluminio verniciato completo di policarbonato PMMA. Disponibile nelle finiture bianco, gold, corten, ardesia, grigio e nero. L'essenzialità della linea ne permette l'utilizzo in qualsiasi ambiente sia lavorativo che domestico.

Ceiling lights, pendant lamps, and LED appliques realised in painted aluminium completed with polycarbonate PMMA. Available in white, golden, corten, dark grey, grey and black finishings. The essentiality of this line of products permits the use of them both at the work place and at home.



OMICRON PLAFONE 220/240 V



Watt/m	1 Linea Led Code - 10 cm	2 Linee Led Code - 10cm	Color	Led
19,2	98210108	98210208	3 Gold	1 4000°K
20,2	98310108	98310208	4 Corten	6 3000°K
14,4	98410108	98410208	5 White	8 2700°K
			6 Ardesia	
			7 Grey	
			9 Black	

Code 1 LINEA	Linee x W/mt	Led/mt	Lm/mt 4000°K	Lm/mt 3000°K	Lm/mt 2700°K	Code 2 LINEE	Linee x W/mt	Led/mt	Lm/mt 4000°K	Lm/mt 3000°K	Lm/mt 2700°K
98210108	1x19,2	240	1580	1540	1490	98210208	2x19,2	480	3160	3080	2980
98310108	1x20,2	224	3114	2937	2740	98310208	2x20,2	448	6228	5874	5480
98410108	1x14,4	140	1947	1836	1712	98410208	2x14,4	280	3894	3672	3424

24 Vdc CRI90 E/F SDCM3 30.000h -20° +40° 14,4 5,1 cm - 19,2 2,5 cm - 20,2 3,57 cm

Il codice del prodotto è riferito a 10 cm di plafoniera. In fase d'ordine precisare la misura della plafoniera richiesta.
Code number refer to 10 cm of ceiling fixture. Ordering specify the length of the ceiling fixture required.

SCHERMI



1 Satinato

4 Curvo

5 Prismatico

ACCESSORI

UGR<19

9895

Utilizzabile solo con schermo prismatico e profili con una linea Led.
Use only with prismatic screen and profiles with 1 line Led.

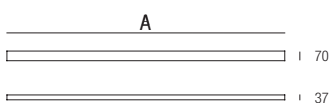

A: Color: 4-5-6-7-9 max cm 300 - 3 max cm 200

Ⓡ Led CRI >90 E/F CE IP 40



OMICRON PLAFONIERE

OMICRON SL3 / SL6

Modulo 3 o 6 Led fissi - Module 3/6 fixed Led
9/18w tot 700mA 720/1440 lm tot

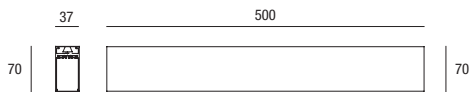

Code - 3 luci	Color	Led	Ottica
98212108	3 Gold	1 4000°K	1 25°
	4 Corten	6 3000°K	6 60°
	5 White		
Code - 6 luci	6 Ardesia		
	7 Grey		
	9 Black		

Color: 3-4-5-6-7 policarbonato satinato
 Color: 9 policarbonato nero



OMICRON SLO6

Plafoniera 6 Led orientabili - Ceiling lamp with 6 adjustable Leds
18w tot 700mA nero 1440 lm tot

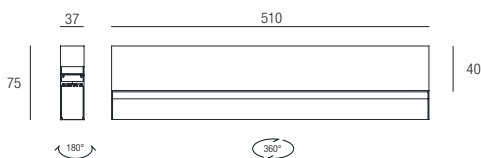

Code	Color	Led	Ottica
98212308	3 Gold	1 4000°K	1 25°
	4 Corten	6 3000°K	6 60°
	5 White		
6 Ardesia			
7 Grey			
9 Black			

Color: 3-4-5-6-7 policarbonato satinato
 Color: 9 policarbonato nero



OMICRON SLO3

Plafoniera 3 Led orientabili - Ceiling lamp with 3 adjustable Leds
3x3w tot 700mA 720 lm tot

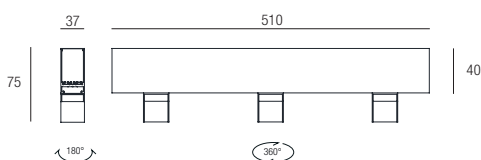

Code	Color	Led	Ottica
98212408	3 Gold	1 4000°K	1 25°
	4 Corten	6 3000°K	6 60°
	5 White		
6 Ardesia			
7 Grey			
9 Black			

Color: 3-4-5-6-7 policarbonato satinato
 Color: 9 policarbonato nero



OMICRON PLAFONIERE

OMICRON SL04

Plafoniera 2+2 Led orientabili - Ceiling lamp 2+2 adjustable Leds
4x3w tot 700mA 960 lm tot

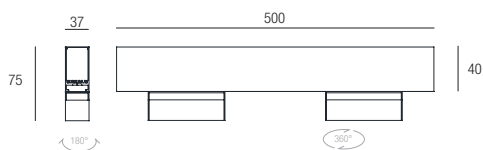

Code	Color	Led	Ottica
98212508	3 Gold	1 4000°K	1 25°
	4 Corten	6 3000°K	6 60°
	5 White	8 2700°K	
	6 Ardesia		
	7 Grey		
	9 Black		
	Color: 3-4-5-6-7 policarbonato satinato		
	Color: 9 policarbonato nero		



OMICRON SL

Plafoniera orientabile con 1 o 2 linee Led - Adjustable ceiling lamp with 1 or 2 Led lines
 9,5w -19w 24Vdc

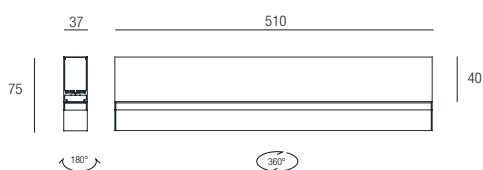

1 Linea Led	2 Linee Led	Color	Led
Code 98211908	Code 98212008	3 Gold	1 4000°K
		4 Corten	6 3000°K
		5 White	
		6 Ardesia	
		7 Grey	
		9 Black	

Code	Watt	Lumen	Lumen	Lumen
1 LINEA		4000°K	3000°K	2700°K
98211908	9,5	1445	1365	1272
Code	Watt	Lumen	Lumen	Lumen
2 LINEE		4000°K	3000°K	2700°K
98212008	19	2890	2730	2540





OMICRON

Faretto con 2 luci orientabili - Spot with 2 adjustable Leds

2x3w tot 700mA 480 lm tot

Code	Color	Led	Ottica
98213208	3 Gold	1 4000°K	1 25°
	4 Corten	6 3000°K	6 60°
	5 White		
	6 Ardesia		
	7 Grey		
9 Black			

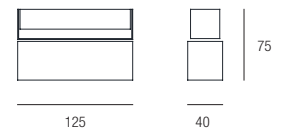





Color: 3-4-5-6-7 policarbonato satinato
 Color: 9 policarbonato nero





OMICRON LED SOSPENSIONE 220/240

Watt/m	1 Linea Led	2 Linee Led	1+1 Linea Led	1+2 Linee Led	Color	Led
	Code - 10 cm	Code - 10 cm	Code - 10 cm	Code - 10 cm		
19,2	98510108	98510208	98511108	98511208	3 Gold	1 4000°K
20,2	98710108	98710208	98711108	98711208	4 Corten	6 3000°K
14,4	98810108	98810208	98811108	98811208	5 White	8 2700°K
					6 Ardesia	
					7 Grey	
					9 Black	

Code	Linee x	Led/mt	Lm/mt	Lm/mt	Lm/mt	Code	Linee x	Led/mt	Lm/mt	Lm/mt	Lm/mt
1 LINEA	W/mt		4000°K	3000°K	2700°K	2 LINEE	W/mt		4000°K	3000°K	2700°K
98510108	1x19,2	240	1580	1540	1490	98510208	2x19,2	480	3160	3080	2980
98710108	1x20,2	224	3114	2937	2740	98710208	2x20,2	448	6228	5874	5480
98810108	1x14,4	140	1947	1836	1712	98810208	2x14,4	280	3894	3672	3424

Code	Linee x	Led/mt	Lm/mt	Lm/mt	Lm/mt	Code	Linee x	Led/mt	Lm/mt	Lm/mt	Lm/mt
1+1 LINEA	W/mt		4000°K	3000°K	2700°K	1+2 LINEE	W/mt		4000°K	3000°K	2700°K
98511108	1+1x19,2	240+240	1580+1580	1540+1540	1490+1490	98511208	1+2x19,2	240+480	1580+3160	1540+3080	1490+2980
98711108	1+1x20,2	224+224	3114+3114	2937+2937	2740+2740	98711208	1+2x20,2	224+448	3114+6228	2937+5874	2740+5480
98811108	1+1x14,4	140+140	1947+1947	1836+1836	1712+1712	98811208	1+2x14,4	140+280	1947+3894	1836+3672	1712+3424

24 Vdc CRI90 E/F SDCM3 30.000h -20° +40° 14,4 5,1 cm - 19,2 2,5 cm - 20,2 3,57 cm

Il codice del prodotto è riferito a 10 cm di sospensione. In fase d'ordine precisare la misura della sospensione richiesta.
Code number refer to 10 cm of suspension. Ordering specify the length of the suspension required.

SCHERMI



1 Satinato 4 Curvo 5 Prismatico

ACCESSORI



9895

Utilizzabile solo con schermo prismatico e sospensioni con una linea Led.
Use only with prismatic screen and suspensions with 1 line Led.

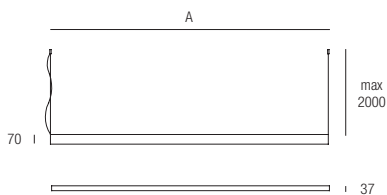

A: Color: 4-5-6-7-9 max cm 300 - 3 max cm 200

LED CRI >90 E/F CE IP 40

OMICRON applique

Design Athena

Lampade da parete realizzate in alluminio estruso disponibili in 5 misure, finitura bianca, nera, grigia, oro, corten e ardesia.
Le appliques possono essere congiunte tra loro con l'apposito accessorio.

Wall lamps available in 5 sizes, in 5 colours (white, black, grey, gold, corten and dark grey). Wall lamps may be connected in a continuous line by apposite junction kit.



APPLIQUE LED 350 220/240V

Code	Color	Led
98610121	3 Gold	1 LINEA LED
	4 Corten	1 4000°K - 7W 999 lm
	5 White	6 3000°K - 7W 936 lm
	6 Ardesia	
	7 Grey	
	9 Black	
98610221	3 Gold	2 LINEE LED
	4 Corten	1 4000°K - 13W 1998 lm
	5 White	6 3000°K - 13W 1872 lm
	6 Ardesia	
	7 Grey	
	9 Black	
98611121	3 Gold	1+1 LINEA LED
	4 Corten	1 4000°K - 13W 999+777 lm
	5 White	6 3000°K - 13W 936+728 lm
	6 Ardesia	
	7 Grey	
	9 Black	
98611221	3 Gold	1+2 LINEE LED
	4 Corten	1 4000°K - 18,5W 777+1998 lm
	5 White	6 3000°K - 18,5W 728+1872 lm
	6 Ardesia	
	7 Grey	
	9 Black	



350

| 70

| 37

Led CRI >90 E



APPLIQUE LED 600 220/240V

Code	Color	Led
98610122	3 Gold	1 LINEA LED
	4 Corten	1 4000°K - 12W 1776 lm
	5 White	6 3000°K - 12W 1664 lm
	6 Ardesia	
	7 Grey	
	9 Black	
98610222	3 Gold	2 LINEE LED
	4 Corten	1 4000°K - 24W 3552 lm
	5 White	6 3000°K - 24W 3328 lm
	6 Ardesia	
	7 Grey	
	9 Black	
98611122	3 Gold	1+1 LINEA LED
	4 Corten	1 4000°K - 24W 1776+1665 lm
	5 White	6 3000°K - 24W 1664+1560 lm
	6 Ardesia	
	7 Grey	
	9 Black	
98611222	3 Gold	1+2 LINEE LED
	4 Corten	1 4000°K - 35W 1665+3552 lm
	5 White	6 3000°K - 35W 1560+3328 lm
	6 Ardesia	
	7 Grey	
	9 Black	



600

| 70

| 37

Led CRI >90 E



APPLIQUE LED 900 220/240V

Code	Color	Led
98610123	3 Gold	1 LINEA LED
	4 Corten	1 4000°K - 19W 2775 lm
	5 White	6 3000°K - 19W 2600 lm
	6 Ardesia	
	7 Grey	
	9 Black	
98610223	3 Gold	2 LINEE LED
	4 Corten	1 4000°K - 38W 5550 lm
	5 White	6 3000°K - 38W 5200 lm
	6 Ardesia	
	7 Grey	
	9 Black	
98611123	3 Gold	1+1 LINEA LED
	4 Corten	1 4000°K - 38W 2775+2664 lm
	5 White	6 3000°K - 38W 2600+2496 lm
	6 Ardesia	
	7 Grey	
	9 Black	
98611223	3 Gold	1+2 LINEE LED
	4 Corten	1 4000°K - 56W 2664+5550 lm
	5 White	6 3000°K - 56W 2496+5200 lm
	6 Ardesia	
	7 Grey	
	9 Black	



900

| 70

| 37

Led CRI >90 E



















A richiesta misure personalizzate
Custom measurements on demand

**Code** KIT CONGIUNZIONE**9862**











Le applique possono essere congiunte in linea fra loro con il kit congiunzione 9862.
Wall lamp may be connected in a continuous line by junction 9862.

APPLIQUE LED 1500 220/240V

Code	Color	Led			
98610124	3 Gold	1 LINEA LED			
	4 Corten	1 4000°K - 31W 4662 lm			
	5 White	6 3000°K - 31W 4368 lm			2700
	6 Ardesia				
	7 Grey	2 LINEE LED			
	9 Black	1 4000°K - 62W 9324 lm			
98610224		6 3000°K - 62W 8736 lm			2760
98611124		1+1 LINEA LED			
		1 4000°K - 62W 4440+4662 lm			2760
98611224		6 3000°K - 62W 4160+4368 lm			
		1+2 LINEE LED			
		1 4000°K - 92W 4440+9324 lm			
		6 3000°K - 92W 4160+8736 lm			2820

Led CRI >90 
   IP 40  

APPLIQUE LED 2000 220/240V

Code	Color	Led			
98610125	3 Gold	1 LINEA LED			
	4 Corten	1 4000°K - 41W 6216 lm			
	5 White	6 3000°K - 41W 5824 lm			3240
	6 Ardesia				
	7 Grey	2 LINEE LED			
	9 Black	1 4000°K - 82W 12432 lm			
98610225		6 3000°K - 82W 11648 lm			3320
98611125		1+1 LINEA LED			
		1 4000°K - 82W 5883+6216 lm			3320
98611225		6 3000°K - 82W 5512+5824 lm			
		1+2 LINEE LED			
		1 4000°K - 121W 5583+12432 lm			
		6 3000°K - 121W 5512+11648 lm			3400

Led CRI >90 
   IP 40  

A richiesta misure personalizzate
 Custom measurements on demand

**Code** KIT CONGIUNZIONE**9862**

Le applique possono essere congiunte in linea fra loro con il kit congiunzione 9862.
 Wall lamp may be connected in a continuous line by junction 9862.



SLASH

Design Athena

Composizioni con misure predefinite SLASH, Led bi-direzionale su entrambe le barre e alimentatore integrato. Disponibili in varie finiture e con la possibilità di variare la finitura tra la base e la barra sovrapposta.







Compositions with SLASH predefined measures, bi-directional led lights on both bars and power supply included. Available in various finishings and with the possibility to vary the finish between the base and the overlapping bar.

La posizione delle barre va definita in fase di installazione. Una volta installate le barre non sono orientabili. A richiesta misure personalizzate.

The position of the bar must be defined while installing it, as their orientation cannot be changed after that.



APPLIQUE/PLAFONE LED 114W 220/240V



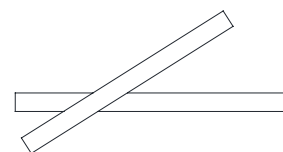



Code	Color	Led
407121	4  Corten	1  4000°K - 114W 17400 lm
	5  White	6  3000°K - 114W 16440 lm
	6  Ardesia	8  2700°K - 114W 15300 lm
	9  Black	



Slash base: cm 150
Slash c/distanziale: cm 130

Led CRI >90   IP 20    

APPLIQUE/PLAFONE LED 114W 220/240V



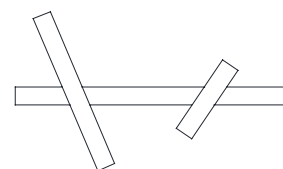



Code	Color	Led
407122	4  Corten	1  4000°K - 114W 17400 lm
	5  White	6  3000°K - 114W 16440 lm
	6  Ardesia	8  2700°K - 114W 15300 lm
	9  Black	



Slash base: cm 150
Slash c/distanziale: cm 90+45

Led CRI >90   IP 20    

APPLIQUE/PLAFONE LED 60W 220/240V







Code	Color	Led
407123	4  Corten	1  4000°K - 60W 9340 lm
	5  White	6  3000°K - 60W 8800 lm
	6  Ardesia	8  2700°K - 60W 8200 lm
	9  Black	



Slash base: cm 100
Slash c/distanziale: cm 50

Led CRI >90   IP 20    

APPLIQUE/PLAFONE LED 134W 220/240V



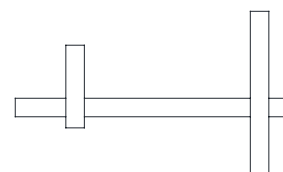



Code	Color	Led
407124	4  Corten	1  4000°K - 134W 20670 lm
	5  White	6  3000°K - 134W 19500 lm
	6  Ardesia	8  2700°K - 134W 18180 lm
	9  Black	



Slash base: cm 200
Slash c/distanziale: cm 90+45

Led CRI >90   IP 20    





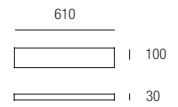

APPLIQUE /PLAFONE LED 600 24W 220/240V

Code	Color	Led
406122	4  Corten	1  4000°K - 24W 3550 lm
	5  White	6  3000°K - 24W 3348 lm
	6  Ardesia	8  2700°K - 24W 3120 lm
	9  Black	



Led CRI >90   IP 20     
780





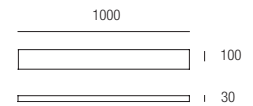

APPLIQUE /PLAFONE LED 1000 40W 220/240V

Code	Color	Led
406123	4  Corten	1  4000°K - 40W 6228 lm
	5  White	6  3000°K - 40W 5874 lm
	6  Ardesia	8  2700°K - 40W 5480 lm
	9  Black	



Led CRI >90   IP 20     
1300





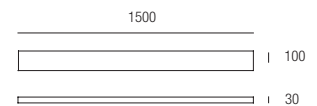

APPLIQUE /PLAFONE LED 1500 60W 220/240V

Code	Color	Led
406124	4  Corten	1  4000°K - 60W 9340 lm
	5  White	6  3000°K - 60W 8810 lm
	6  Ardesia	8  2700°K - 60W 8210 lm
	9  Black	



Led CRI >90   IP 20     
1800

APPLIQUE /PLAFONE LED 2000 80W 220/240V

Code	Color	Led
406125	4  Corten	1  4000°K - 80W 12450 lm
	5  White	6  3000°K - 80W 11740 lm
	6  Ardesia	8  2700°K - 80W 10950 lm
	9  Black	

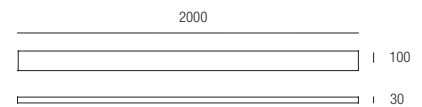

Led CRI >90   IP 20     
2300



INCROCIO

Design Athena

Serie di sospensioni, plafoniere ed applique LED realizzate in alluminio con finitura bianca, ardesia, grigia e nera. Alimentatore incluso.

Collection of suspension, ceiling and wall lamps LED available in aluminium with white, dark grey, grey and black finishes. Driver included.

A richiesta misure personalizzate.

Customized sizes on demand.

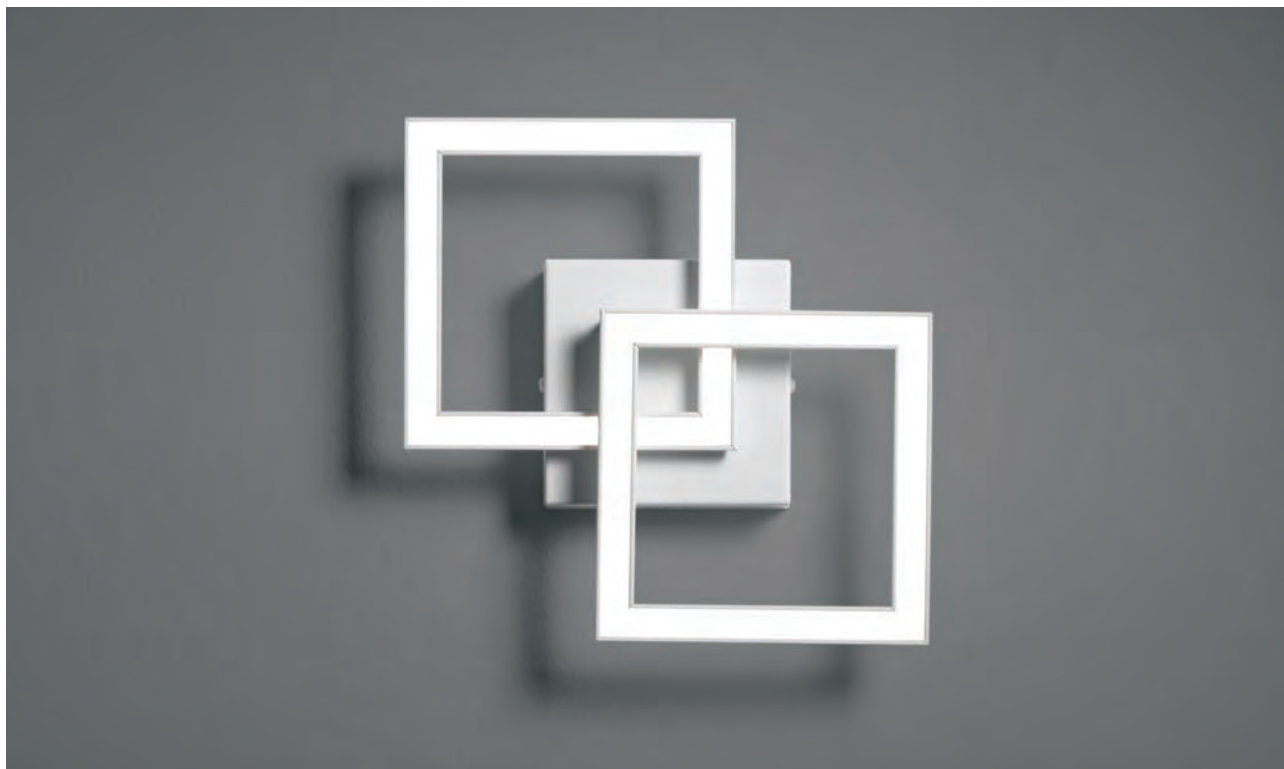

APPLIQUE/PLAFONE LED 18W 220/240V

Code	Color	Led
59161	5 White	1 4000°K - 2320 lm
	6 Ardesia	6 3000°K - 2200 lm
	7 Grey	8 2700°K - 2050 lm
	9 Black	

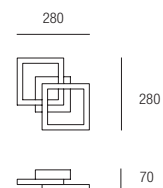

Led CRI 90 IP 20 1120

APPLIQUE/PLAFONE LED 9W 220/240V

Code	Color	Led
59162	5 White	1 4000°K - 1160 lm
	6 Ardesia	6 3000°K - 1100 lm
	7 Grey	8 2700°K - 1025 lm
	9 Black	

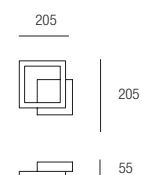

Led CRI 90 IP 20 800



APPLIQUE/PLAFONE LED 18W 220/240V

Code	Color	Led
59122	5 White	1 4000°K - 2336 lm
	6 Ardesia	6 3000°K - 2200 lm
	7 Grey	8 2700°K - 2054 lm
	9 Black	

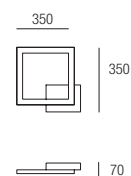

APPLIQUE/PLAFONE LED 23W 220/240V

Code	Color	Led
59222	5 White	1 4000°K - 3550 lm
	6 Ardesia	6 3000°K - 3350 lm
	7 Grey	8 2700°K - 3130 lm
	9 Black	

Led CRI 90 IP 20 **59122** **59222**
1650 1720

APPLIQUE/PLAFONE LED 21W 220/240V

Code	Color	Led
59124	5 White	1 4000°K - 2720 lm
	6 Ardesia	6 3000°K - 2570 lm
	7 Grey	8 2700°K - 2395 lm
	9 Black	

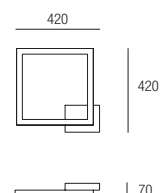

APPLIQUE/PLAFONE LED 29W 220/240V

Code	Color	Led
59224	5 White	1 4000°K - 4484 lm
	6 Ardesia	6 3000°K - 4230 lm
	7 Grey	8 2700°K - 3910 lm
	9 Black	

Led CRI 90 IP 20 **59124** **59224**
1890 1980

APPLIQUE/PLAFONE LED 26W 220/240V

Code	Color	Led
59126	5 White	1 4000°K - 3504 lm
	6 Ardesia	6 3000°K - 3305 lm
	7 Grey	8 2700°K - 3080 lm
	9 Black	

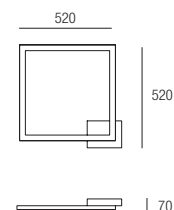

APPLIQUE/PLAFONE LED 38W 220/240V

Code	Color	Led
59226	5 White	1 4000°K - 5854 lm
	6 Ardesia	6 3000°K - 5521 lm
	7 Grey	8 2700°K - 5080 lm
	9 Black	

Led CRI 90 IP 20 **59126** **59226**
2220 2530



APPLIQUE/PLAFONE LED 36W 220/240V

Code	Color	Led
59121	5 White	1 4000°K - 4672 lm
	6 Ardesia	6 3000°K - 4400 lm
	7 Grey	8 2700°K - 4108 lm
	9 Black	

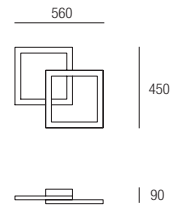

APPLIQUE/PLAFONE LED 46W 220/240V

Code	Color	Led
59221	5 White	1 4000°K - 7100 lm
	6 Ardesia	6 3000°K - 6700 lm
	7 Grey	8 2700°K - 6260 lm
	9 Black	

Led CRI 90 IP 20 **59121** **59221**
2130 2380

APPLIQUE/PLAFONE LED 42W 220/240V

Code	Color	Led
59123	5 White	1 4000°K - 5440 lm
	6 Ardesia	6 3000°K - 5140 lm
	7 Grey	8 2700°K - 4790 lm
	9 Black	

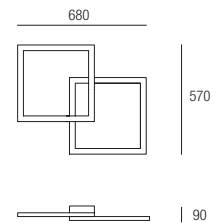

APPLIQUE/PLAFONE LED 58W 220/240V

Code	Color	Led
59223	5 White	1 4000°K - 8968 lm
	6 Ardesia	6 3000°K - 8460 lm
	7 Grey	8 2700°K - 7820 lm
	9 Black	

Led CRI 90 IP 20 **59123** **59223**
2800 3100

APPLIQUE/PLAFONE LED 52W 220/240V

Code	Color	Led
59125	5 White	1 4000°K - 7009 lm
	6 Ardesia	6 3000°K - 6609 lm
	7 Grey	8 2700°K - 6160 lm
	9 Black	

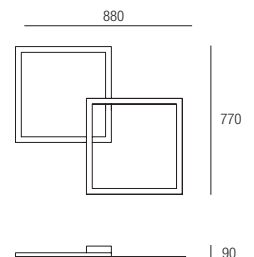

APPLIQUE/PLAFONE LED 76W 220/240V

Code	Color	Led
59225	5 White	1 4000°K - 11680 lm
	6 Ardesia	6 3000°K - 11013 lm
	7 Grey	8 2700°K - 10160 lm
	9 Black	

Led CRI 90 IP 20 **59126** **59226**
3380 3700



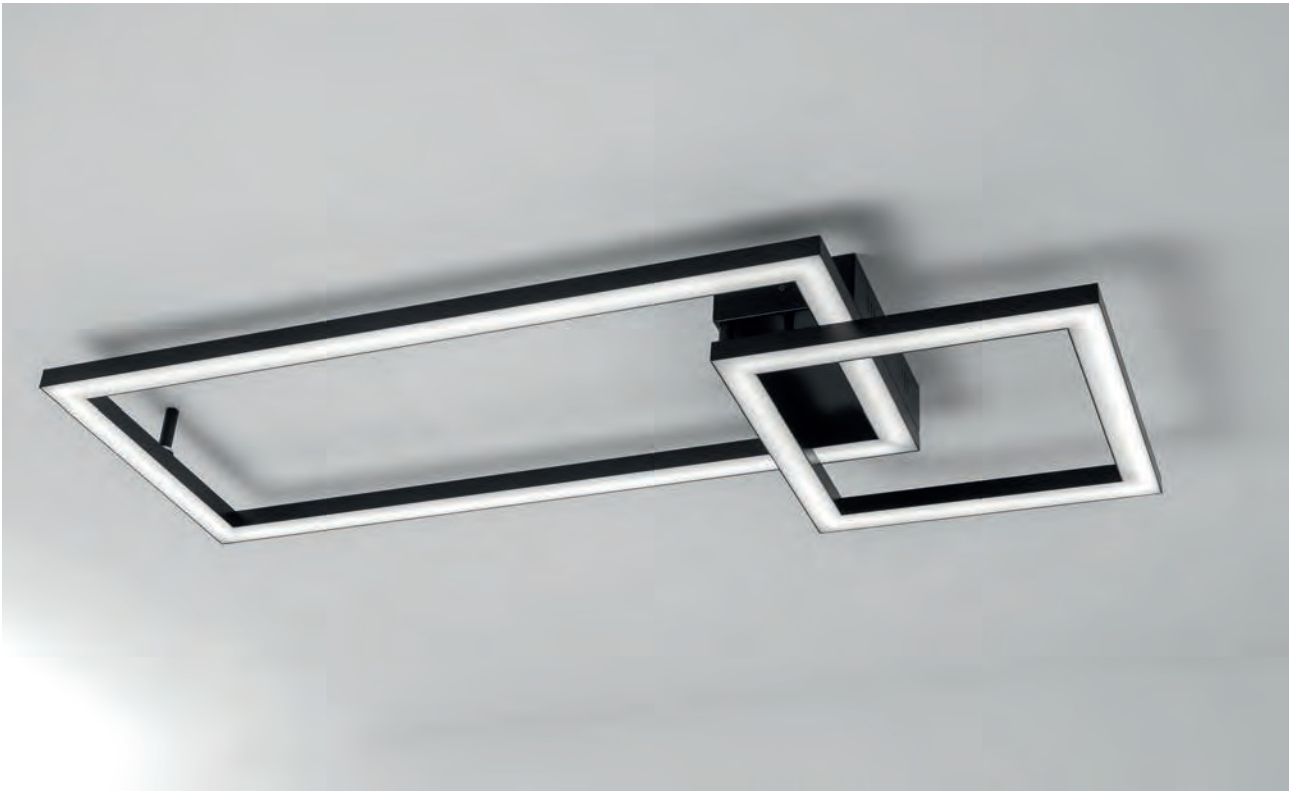

APPLIQUE/PLAFONE LED 47W 220/240V

Code	Color	Led
59127	5 White	1 4000°K - 6327 lm
	6 Ardesia	6 3000°K - 5967 lm
	7 Grey	8 2700°K - 5470 lm
	9 Black	

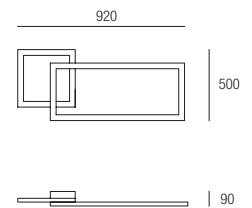

APPLIQUE/PLAFONE LED 64W 220/240V

Code	Color	Led
59227	5 White	1 4000°K - 9870 lm
	6 Ardesia	6 3000°K - 9310 lm
	7 Grey	8 2700°K - 8900 lm
	9 Black	

Led CRI 90 IP 20 **59127** **59227**
 3800 4240

APPLIQUE/PLAFONE LED 58W 220/240V

Code	Color	Led
59128	5 White	1 4000°K - 7788 lm
	6 Ardesia	6 3000°K - 7344 lm
	7 Grey	8 2700°K - 6845 lm
	9 Black	

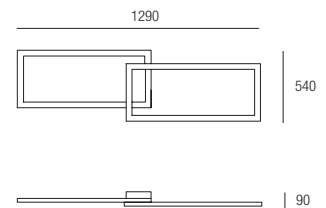

Led CRI 90 IP 20 4680





SOSPENSIONE LED 51W 220/240V

Code	Color	Led
59151	5 White	1 4000°K - UP 975 lm DOWN 5440 lm
	6 Ardesia	6 3000°K - UP 918 lm DOWN 5140 lm
	7 Grey	8 2700°K - UP 856 lm DOWN 4790 lm
	9 Black	

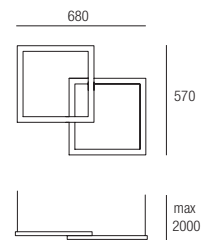

Led CRI 90 IP 20 3120

SOSPENSIONE LED 64W 220/240V

Code	Color	Led
59152	5 White	1 4000°K - UP 1362 lm DOWN 7009 lm
	6 Ardesia	6 3000°K - UP 1285 lm DOWN 6609 lm
	7 Grey	8 2700°K - UP 1190 lm DOWN 6160 lm
	9 Black	

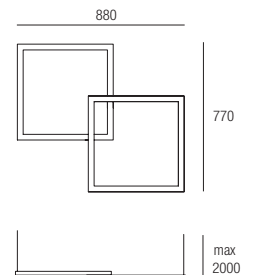

Led CRI 90 IP 20 3560



SOSPENSIONE LED 62W 220/240V

Code	Color	Led
59153	5 White	1 4000°K - UP 1947 lm DOWN 6327 lm
	6 Ardesia	6 3000°K - UP 1836 lm DOWN 5967 lm
	7 Grey	8 2700°K - UP 1712 lm DOWN 5470 lm
	9 Black	

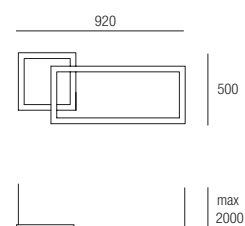

Led CRI 90 IP 20 3750

SOSPENSIONE LED 73W 220/240V

Code	Color	Led
59154	5 White	1 4000°K - UP 3890 lm DOWN 7788 lm
	6 Ardesia	6 3000°K - UP 3670 lm DOWN 7344 lm
	7 Grey	8 2700°K - UP 3420 lm DOWN 6845 lm
	9 Black	

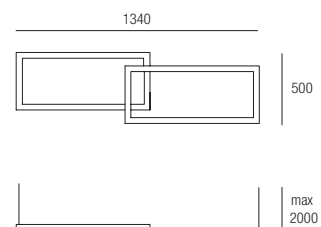

Led CRI 90 IP 20 4870

EDERA

Design Athena

Collezione di sospensioni in vetro disponibili nelle versioni trasparente e nei nuovi colori di tendenza pink gold e black chrome.

L'ampia gamma di sorgenti luminose e dei contenitori di alimentazione permettono la massima versatilità della collezione. La lunghezza dei cavi permette di raggiungere i punti alimentazione in qualsiasi punto siano presenti nell'ambiente. La varietà dei modelli e delle combinazioni possibili rendono la collezione ottimale per ogni ambiente, sia domestico che lavorativo.

Glass hanging lights collection available in two different versions: transparent and in the new trending colours pink gold and black chrome.

The wide range of light sources and of power containers allow the maximum versatility of the collection. The length of the cables allows to reach the power points whenever they are put in the location. The variety of the models and the possible combinations make the collection optimal for every location, whether it is home or work environment.



Sorgenti luminose
Lighting sources



Code	Color	Glass	Lamp
764730 cavo cm 300	1 Chrome	1 Clear	G4 12 Vdc Led
764760 cavo cm 600		3 Pink gold	G6,35 12 Vdc Led
		9 Black chrome	

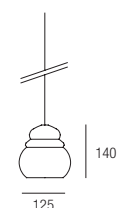
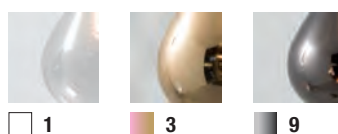

CE IP 20 240



Code	Color	Glass	Lamp
764830 cavo cm 300	1 Chrome	1 Clear	G4 12 Vdc Led
764860 cavo cm 600		3 Pink gold	G6,35 12 Vdc Led
		9 Black chrome	

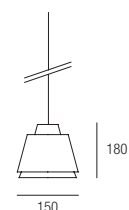
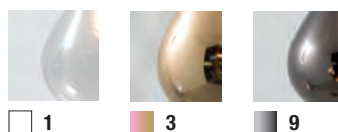

CE IP 20 370



Code	Color	Glass	Lamp
763130 cavo cm 300	1 Chrome	1 Clear	G4 12 Vdc Led
763160 cavo cm 600			G6,35 12 Vdc Led

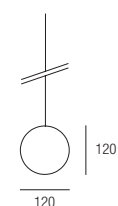

CE IP 20 210

Sorgenti luminose
Lighting sources



Code	Color	Glass	Lamp
763530 cavo cm 300	1 Chrome	1 Clear	G4 12 Vdc Led
763560 cavo cm 600		3 Pink gold	G6,35 12 Vdc Led
		9 Black chrome	

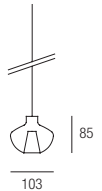
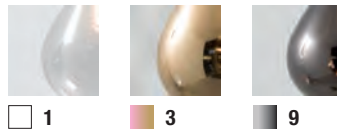

CE IP 20 185



Code	Color	Glass	Lamp
764430 cavo cm 300	1 Chrome	1 Clear	G4 12 Vdc Led
764460 cavo cm 600		3 Pink gold	G6,35 12 Vdc Led
		9 Black chrome	

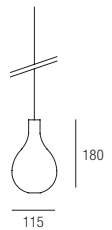
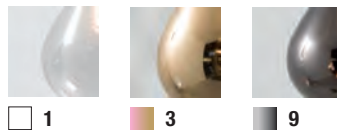

CE IP 20 205



Code	Color	Glass	Lamp
764630 cavo cm 300	1 Chrome	1 Satin	G4 12 Vdc Led
764660 cavo cm 600			G6,35 12 Vdc Led

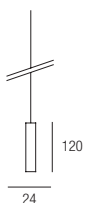





CE IP 20 120



Sorgenti luminose
Lighting sources



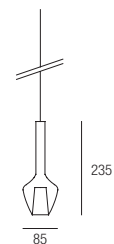
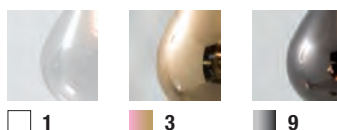

Code	Color	Glass	Lamp
764930 cavo cm 300	1  Chrome	1  Clear	G4 12 Vdc Led
764960 cavo cm 600		3  Pink gold	G6,35 12 Vdc Led
		9  Black chrome	



CE IP 20   
250



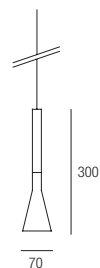

Code	Color	Glass	Lamp
763930 cavo cm 300	1  Chrome	1  Satin	G4 12 Vdc Led
763960 cavo cm 600			G5,3 12 Vdc Led
			G6,35 12 Vdc Led



CE IP 20   
235



Code	Color	Glass	Lamp
764030 cavo cm 300	1  Chrome	1  Satin	G4 12 Vdc Led
764060 cavo cm 600			G5,3 12 Vdc Led
			G6,35 12 Vdc Led

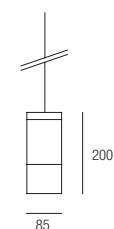

CE IP 20   
370





ACCESSORI EDERA



Base 5 fori uscita cavi
20W 12 VDC Alimentatore incluso
 Base with 5 holes for cable exit
 20W 12 VDC Driver included

Code**Color****1293****3** ■ Gold**5** ■ White**9** ■ Black

□ | 45
 — 20

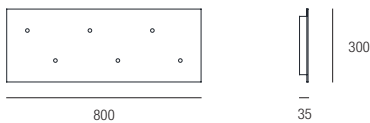

Base rettangolare 6 fori uscita cavi
20W 12 VDC Alimentatore incluso
 Rectangular base with 6 holes for cable exit
 20W 12 VDC Driver included

Code**Color****1294****5** ■ White**9** ■ Black

□ | 300
 — 35



Base tonda 6 fori uscita cavi
20W 12 VDC Alimentatore incluso
 Round base with 6 holes for cable exit
 20W 12 VDC Driver included

Code**Color****1296****5** ■ White**9** ■ Black

Base tonda 8 fori uscita cavi
75W 12 VDC Alimentatore incluso
 Round base with 8 holes for cable exit
 75W 12 VDC Driver included

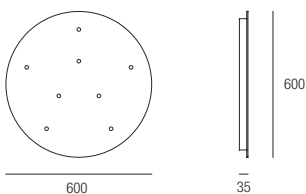
Code**Color****1297****5** ■ White**9** ■ Black

□ | 600
 — 35

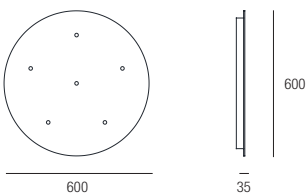
Code 1297

□ | 600
 — 35

Code 1296

ACCESSORI EDERA

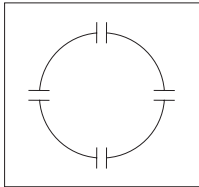

Contenitore 4 fori uscita cavi - 75W 12Vdc
max 8 sospensioni
 Container 75W 12Vdc with 4 holes for cables exit;
 max 8 suspensions

Ø 220 H 45

Code**Color****1279**

3 ■ Gold
5 ■ White
9 ■ Black

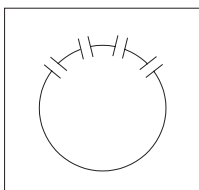

Contenitore 4 fori uscita cavi - 75W 12Vdc
max 12 sospensioni
 Container 75W 12Vdc with 4 holes for cables exit;
 max 12 suspensions

Ø 220 H 45

Code**Color****1283**

3 ■ Gold
5 ■ White
9 ■ Black

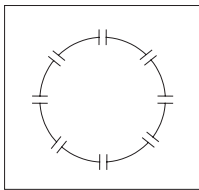

Contenitore 8 fori uscita cavi - 75W 12Vdc
max 24 sospensioni
 Container 75W 12Vdc with 8 holes for cables exit;
 max 24 suspensions

Ø 220 H 45

Code**Color****1284**

3 ■ Gold
5 ■ White
9 ■ Black

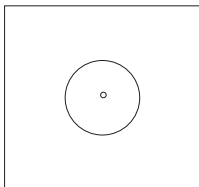

Rosone 1 uscita 10W 12Vdc
 Container with 10W 12Vdc with 1 hole for cable exit

Ø 125 H 30

Code**Color****1287**

3 ■ Gold
5 ■ White
9 ■ Black

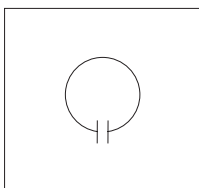

Rosone 1 uscita laterale 10W 12Vdc
max 3 sospensioni
 Container with 10W 12Vdc with 1 side hole for cable exit
 max 3 suspensions

Ø 125 H 30

Code**Color****1288**

3 ■ Gold
5 ■ White
9 ■ Black



Supporto per tenuta cavo
 Support for cable

Code**Color****7003**

1 ■ Chrome

ESEMPI COMPOSIZIONI EDERA

APPLICAZIONI A SOFFITTO

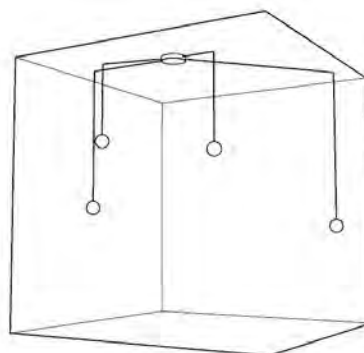
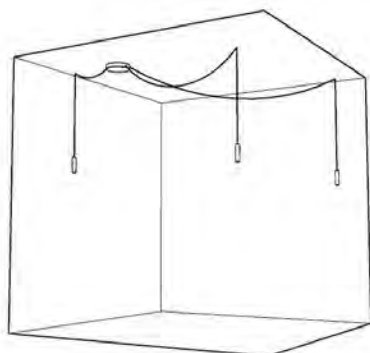

APPLICAZIONI A PARETE

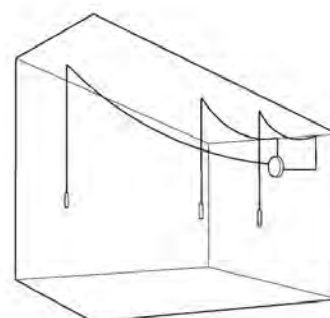
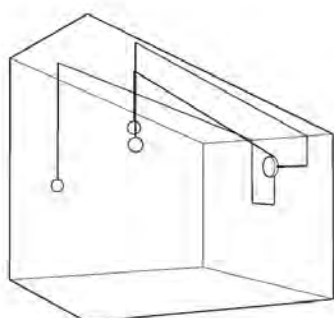
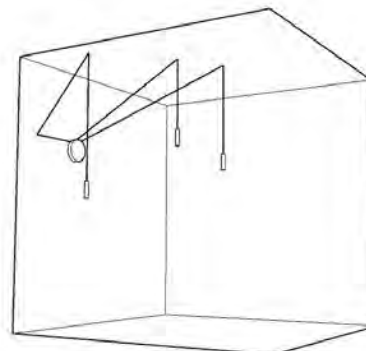
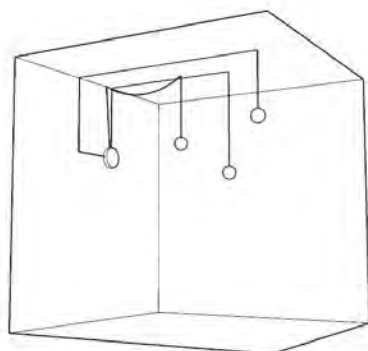

ALVIN

Design Athena

Applique/plafoniera disponibile nelle finiture oro, corten, bianco, ardesia e nero. Alimentatore incluso.
Wall/ceiling lamps available in gold, corten, white, dark grey and black finishes. Driver included.



APPLIQUE / PLAFONE LED 12W 220/240V

Code	Color	Led
6061	3 Gold	1 4000°K - 1786 lm
	4 Corten	6 3000°K - 1678 lm
	5 White	8 2700°K - 1565 lm
	6 Ardesia	
	9 Black	



Led CRI >90 IP 40 1020

APPLIQUE / PLAFONE LED 19W 220/240V

Code	Color	Led
6062	3 Gold	1 4000°K - 2890 lm
	4 Corten	6 3000°K - 2720 lm
	5 White	8 2700°K - 2540 lm
	6 Ardesia	
	9 Black	

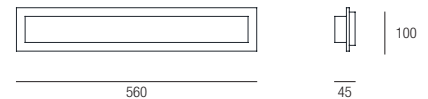

Led CRI >90 IP 40 1580

APPLIQUE / PLAFONE LED 37W 220/240V

Code	Color	Led
6063	3 Gold	1 4000°K - 5560 lm
	4 Corten	6 3000°K - 5244 lm
	5 White	8 2700°K - 4890 lm
	6 Ardesia	
	9 Black	

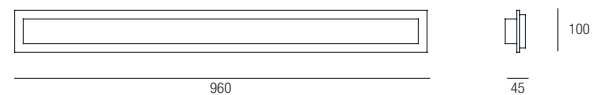

Led CRI >90 IP 40 2430

DADAJE

Design Athena

Collezione di lampade da parete e plafone disponibili nelle finitura oro, corten, bianco, ardesia, grigio e nero.
Collection of wall and ceiling lamps with golden, corten, white, dark grey, grey and black finishes.



APPLIQUE

Led integrato 2x4W - 220/240v dimmerabile

Code	Color	Led
5221	3 Gold	1 4000°K - 320+320 lm
	4 Corten	6 3000°K - 300+300 lm
	5 White	
	6 Ardesia	
	7 Grey	
	9 Black	

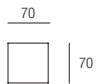

Led CRI >90
 CE IP 40

 320

APPLIQUE

Led integrato 2x15W - 220/240v dimmerabile

Code	Color	Led
5321	3 Gold	1 4000°K - 1150+1150 lm
	4 Corten	6 3000°K - 1080+1080 lm
	5 White	
	6 Ardesia	
	7 Grey	
	9 Black	

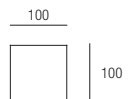

Led CRI >90
 CE IP 40

 570

2 x GX53 - 220/240v

Code	Color	Led
4921	3 Gold	2 x GX53 LED
	4 Corten	
	5 White	
	6 Ardesia	
	7 Grey	
	9 Black	

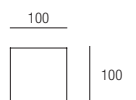

CE IP 20

 450





APPLIQUE ORIENTABILE

Led integrato 8W - 220/240v dimmerabile

Code	Color	Led
5261	3 Gold	1 4000°K - 690 lm
	4 Corten	6 3000°K - 670 lm
	5 White	
	6 Ardesia	
	7 Grey	
	9 Black	

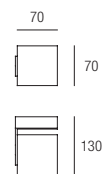

Led CRI >90

 CE IP 40

 GR 430

1 x GU10 - 220/240v

Code	Color	Lamp
4861	3 Gold	1 x GU10 LED
	4 Corten	
	5 White	
	6 Ardesia	
	7 Grey	
	9 Black	

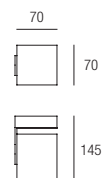

CE IP 20

 GR 470



APPLIQUE/PLAFONIERA

Led integrato 2x8W - 220/240v dimmerabile

Code	Color	Led
5262	3 Gold	1 4000°K - 1380 lm
	4 Corten	6 3000°K - 1340 lm
	5 White	
	6 Ardesia	
	7 Grey	
	9 Black	

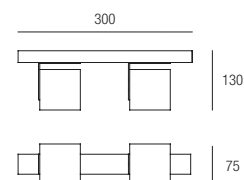

Ⓜ Led CRI >90 **E** CE IP 40 **F** **GR** 1220

2 x GU10 - 220/240v

Code	Color	Lamp
4862	3 Gold	2 x GU10 LED
	4 Corten	
	5 White	
	6 Ardesia	
	7 Grey	
	9 Black	

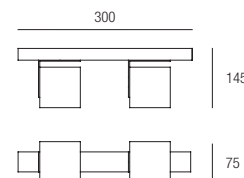

CE IP 20 **F** **GR** 800

APPLIQUE/PLAFONIERA

Led integrato 3x8W - 220/240v dimmerabile

Code	Color	Led
5263	3 Gold	1 4000°K - 2070 lm
	4 Corten	6 3000°K - 2010 lm
	5 White	
	6 Ardesia	
	7 Grey	
	9 Black	

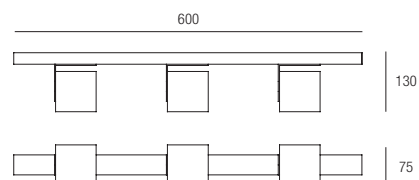

Ⓜ Led CRI >90 **E** CE IP 40 **F** **GR** 1915

3 x GU10 - 220/240v

Code	Color	Lamp
4863	3 Gold	3 x GU10 LED
	4 Corten	
	5 White	
	6 Ardesia	
	7 Grey	
	9 Black	

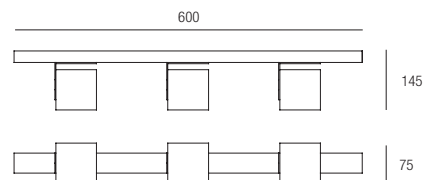









CE IP 20 **F** **GR** 1740



PLAFONIERA







Led integrato 8W - 220/240v dimmerabile

Code	Color	Led
5291	3  Gold	1  4000°K - 690 lm
	4  Corten	6  3000°K - 670 lm
	5  White	
	6  Ardesia	
	7  Grey	
	9  Black	



PLAFONIERA

1 x GU10 - 220/240v







Code	Color	Lamp
4891	3  Gold	1 x GU10 LED
	4  Corten	
	5  White	
	6  Ardesia	
	7  Grey	
	9  Black	



CE IP 20   
290

PLAFONIERA

1 x GU10 - 220/240v



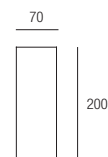



Code	Color	Lamp
4892	3  Gold	1 x GU10 LED
	4  Corten	
	5  White	
	6  Ardesia	
	7  Grey	
	9  Black	



CE IP 20   
420

PLAFONIERA

1 x GU10 - 220/240v

Code	Color	Lamp
4893	3  Gold	1 x GU10 LED
	4  Corten	
	5  White	
	6  Ardesia	
	7  Grey	
	9  Black	

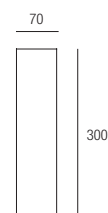

CE IP 20   
570

PLAFONIERA

Led integrato 15W - 220/240v dimmerabile

Code	Color	Led
5391	3 Gold	1 4000°K - 1150 lm
	4 Corten	6 3000°K - 1080 lm
	5 White	
	6 Ardesia	
	7 Grey	
	9 Black	

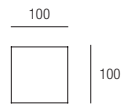

Led CRI >90

 IP 40

 530

1 x GX53 - 220/240v

Code	Color	Lamp
4991	3 Gold	1 x GX53 LED
	4 Corten	
	5 White	
	6 Ardesia	
	7 Grey	
	9 Black	

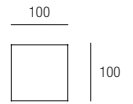

IP 20

 400

PLAFONIERA

1 x GX53 - 220/240v

Code	Color	Lamp
4992	3 Gold	1 x GX53 LED
	4 Corten	
	5 White	
	6 Ardesia	
	7 Grey	
	9 Black	

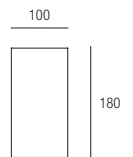

IP 20

 600

LAMPADA DA TAVOLO

1 x GU10 - 220/240v

Code	Color	Lamp
4830	3 Gold	1 x GU10 LED
	4 Corten	
	5 White	
	6 Ardesia	
	7 Grey	
	9 Black	

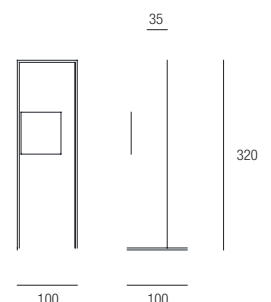

IP 20

 980

Cubetto con attacco magnetico regolabile in varie posizione sulla struttura della lampada.
 Cube with magnetic attachment adjustable in various positions on the structure of the lamp.



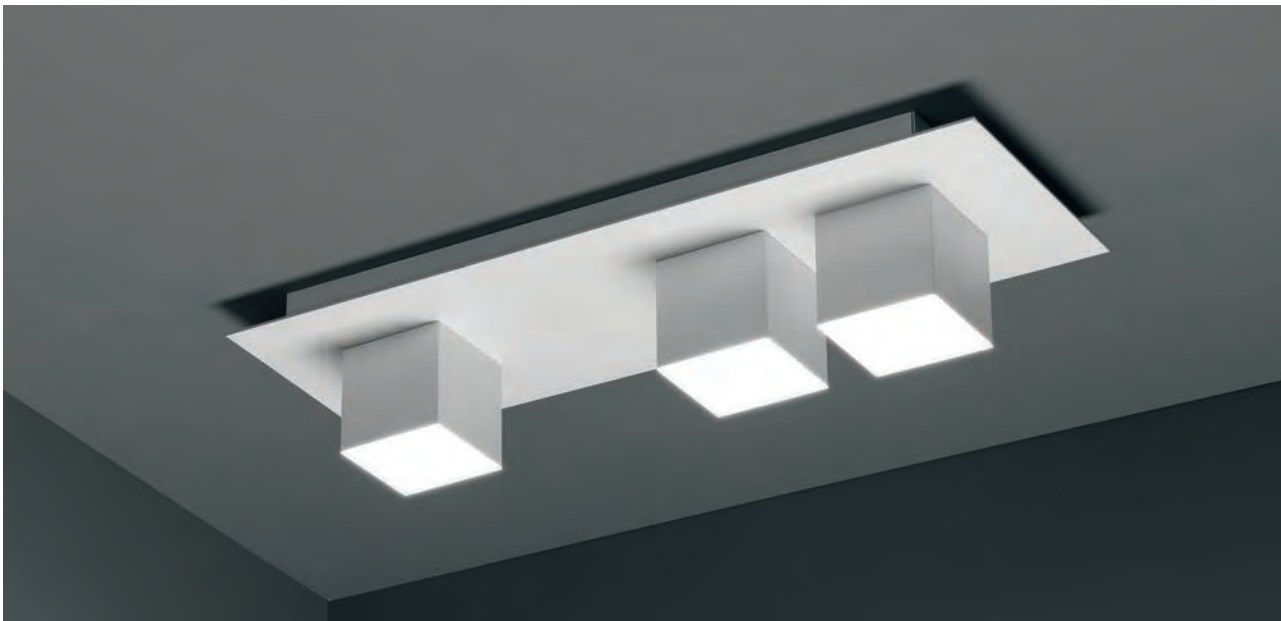

PLAFONIERA

Led integrato 3x8W - 220/240v dimmerabile

Code	Color	Led
5271	3 Gold	1 4000°K - 2070 lm
	4 Corten	
	5 White	6 3000°K - 2010 lm
	6 Ardesia	
	7 Grey	
	9 Black	

3 x GU10 - 220/240v

Code	Color	Lamp
4871	3 Gold	3 x GU10 LED
	4 Corten	
	5 White	
	6 Ardesia	
	7 Grey	
	9 Black	

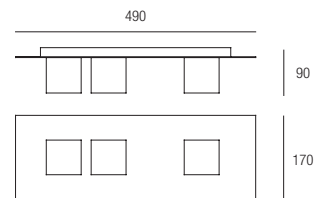

Ⓡ Led CRI >90 IP 40 2760

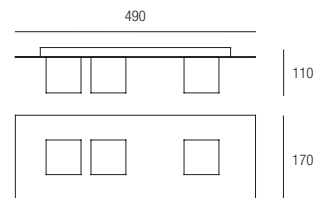

IP 20 2330

PLAFONIERA

Led integrato 2x8W - 220/240v dimmerabile

Code	Color	Led
5272	3 Gold	1 4000°K - 1380 lm
	4 Corten	
	5 White	6 3000°K - 1340 lm
	6 Ardesia	
	7 Grey	
	9 Black	

2 x GU10 - 220/240v

Code	Color	Lamp
4872	3 Gold	2 x GU10 LED
	4 Corten	
	5 White	
	6 Ardesia	
	7 Grey	
	9 Black	

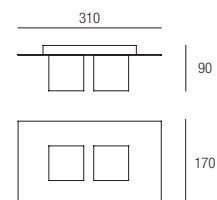

Ⓡ Led CRI >90 IP 40 1790

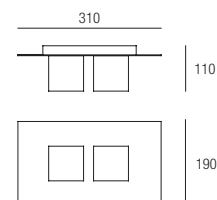

IP 20 1470



PLAFONIERA

Led integrato 46W - 220/240v dimmerabile

Code	Color	Led
5282	3 Gold	1 4000°K - 3680 lm
	4 Corten	6 3000°K - 3500 lm
	5 White	
	6 Ardesia	
	7 Grey	
	9 Black	

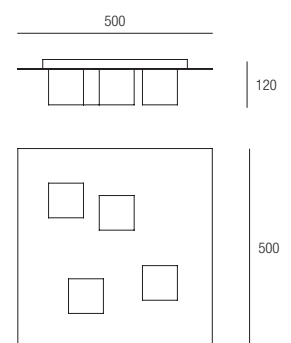

Led CRI >90
 F
 CE
 IP 40

 GR 3980

PLAFONIERA

2 x GU10 + 2 x GX53 - 220/240v

Code	Color	Lamp
4882	3 Gold	2 x GU10 LED
	4 Corten	2 x GX53 LED
	5 White	
	6 Ardesia	
	7 Grey	
	9 Black	

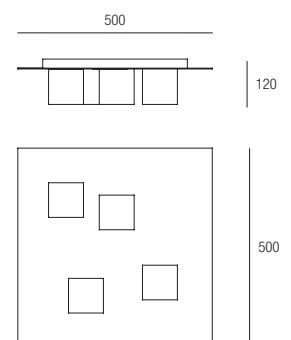

CE
 IP 20

 GR 4370

SOSPENSIONE

Led integrato 8W - 220/240v dimmerabile

Code	Color	Led
5401	3 Gold	1 4000°K - 690 lm
	4 Corten	
	5 White	6 3000°K - 670 lm
	6 Ardesia	
	7 Grey	
	9 Black	

1 x GU10 - 220/240v

Code	Color	Lamp
4801	3 Gold	1 x GU10 LED
	4 Corten	
	5 White	
	6 Ardesia	
	7 Grey	
	9 Black	

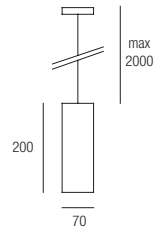

Ⓡ Led CRI >90 **F** **CE** IP 40 **F** **GR** 640

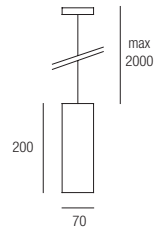

CE IP 20 **F** **GR** 580

SOSPENSIONE

Led integrato 8W - 220/240v dimmerabile

Code	Color	Led
5402	3 Gold	1 4000°K - 690 lm
	4 Corten	
	5 White	6 3000°K - 670 lm
	6 Ardesia	
	7 Grey	
	9 Black	

1 x GU10 - 220/240v

Code	Color	Lamp
4802	3 Gold	1 x GU10 LED
	4 Corten	
	5 White	
	6 Ardesia	
	7 Grey	
	9 Black	

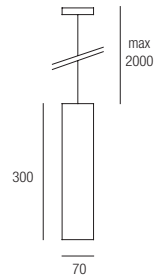

Ⓡ Led CRI >90 **F** **CE** IP 40 **F** **GR** 790

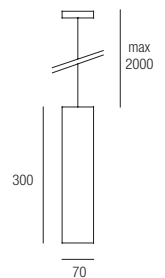

CE IP 20 **F** **GR** 730

ACCESSORI SOSPENSIONI

Code	Color	
1253	3 Gold	Base 3 fori uscita cavi Base with 3 holes for cable exit
	4 Corten	
	5 White	
	6 Ardesia	
	7 Grey	
	9 Black	

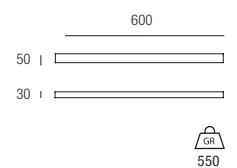

GR 550

Code	Color	
1254	3 Gold	Base 5 fori uscita cavi Base with 5 holes for cable exit
	4 Corten	
	5 White	
	6 Ardesia	
	7 Grey	
	9 Black	

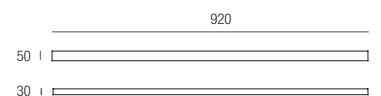

GR 750







PLAFONIERA

1 X GX53 220/240V

Code	Color	Lamp
5091	3 Gold	1 X GX53 LED
	4 Corten	
	5 White	
	6 Ardesia	
	7 Grey	
	9 Black	



CE IP 20   
390

PLAFONIERA

1 x GX53 - 220/240v

Code	Color	Lamp
5092	3 Gold	1 x GX53 LED
	4 Corten	
	5 White	
	6 Ardesia	
	7 Grey	
	9 Black	

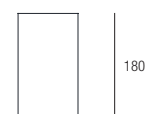

CE IP 20   
530



APPLIQUE ORIENTABILE

1 x GX53 - 220/240v

Code	Color	Lamp
5061	3 Gold	1 x GX53 LED
	4 Corten	
	5 White	
	6 Ardesia	
	7 Grey	
	9 Black	

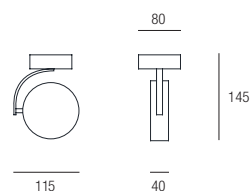

CE IP 20

APPLIQUE/PLAFONIERA

2 x GX53 - 220/240v

Code	Color	Lamp
5062	3 Gold	2 x GX53 LED
	4 Corten	
	5 White	
	6 Ardesia	
	7 Grey	
	9 Black	

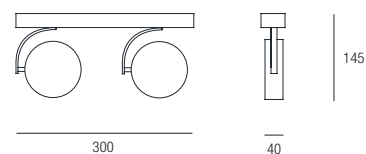

CE IP 20

APPLIQUE/PLAFONIERA

3 x GX53 - 220/240v

Code	Color	Lamp
5063	3 Gold	3 x GX53 LED
	4 Corten	
	5 White	
	6 Ardesia	
	7 Grey	
	9 Black	

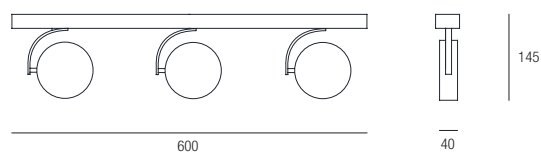

CE IP 20

SOSPENSIONE

1 x GU10 - 220/240V

Code	Color	Lamp
5001	3 Gold	1 x GU10 LED
	4 Corten	
	5 White	
	6 Ardesia	
	7 Grey	
	9 Black	

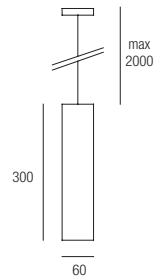
Cavo rosso a richiesta
Red cable on demand

CE IP 20 380

SOSPENSIONE

1 x GU10 - 220/240V

Code	Color	Lamp
5002	3 Gold	1 x GU10 LED
	4 Corten	
	5 White	
	6 Ardesia	
	7 Grey	
	9 Black	

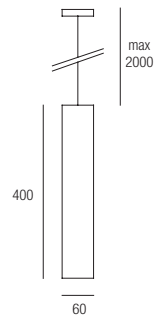
Cavo rosso a richiesta
Red cable on demand

CE IP 20 430

ACCESSORI SOSPENSIONI

Code	Color	Base 3 fori uscita cavi Base with 3 holes for cable exit
1253	3 Gold	
	4 Corten	
	5 White	
	6 Ardesia	
	7 Grey	
	9 Black	

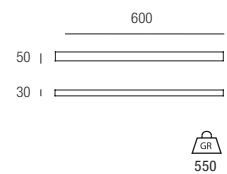

Code	Color	Base 5 fori uscita cavi Base with 5 holes for cable exit
1254	3 Gold	
	4 Corten	
	5 White	
	6 Ardesia	
	7 Grey	
	9 Black	

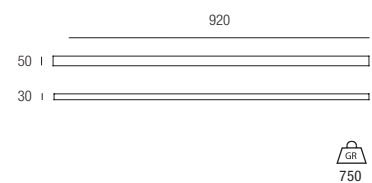



GIOTTO

Design Athena

Serie di sospensioni plafoniere e applique circolari combinabili tra loro, realizzate in alluminio con finitura bianca, nera o oro e montate con Led da 19,2 w/m. Luce naturale, calda. Le sospensioni devono essere completate con il contenitore con l'alimentatore.

Circular suspensions combined together, made of white, black or gold painted aluminium and fitted with 19,2 w/mt strip Led.
Natural and warm light. Suspensions have to be completed with its appropriate box with driver.



Progetto realizzato da arch. Cappelletti

COMPOSIZIONI

Gli elementi a sospensione, di qualsiasi dimensione, possono essere combinati tra loro in base alle proprie esigenze. La composizione degli elementi deve essere completata con il contenitore con alimentatore appropriato alla potenza totale. Suspensions, of any size, can be combined together to suit your needs. Compositions must be completed with the appropriate box with driver.

SOSPENSIONE LED 390 - 23,1W 24 VDC

Code	Color	Led
775119	3 Gold	1 4000°K - 1900 lm
	5 White	6 3000°K - 1850 lm
	9 Black	

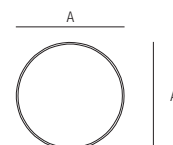

SOSPENSIONE LED 520 - 30,7W 24VDC

Code	Color	Led
775219	3 Gold	1 4000°K - 2530 lm
	5 White	6 3000°K - 2460 lm
	9 Black	



A	Code	Ø	Weight
	775119	Ø 390	460gr
	775219	Ø 520	550gr
	775319	Ø 640	650gr
	775419	Ø 860	710gr

SOSPENSIONE LED 640 - 38,4W 24VDC

Code	Color	Led
775319	3 Gold	1 4000°K - 3160 lm
	5 White	6 3000°K - 3080 lm
	9 Black	

SOSPENSIONE LED 860 - 51,5W 24VDC

Code	Color	Led
775419	3 Gold	1 4000°K - 4230 lm
	5 White	6 3000°K - 4130 lm
	9 Black	

Led CRI >90 IP 40

SOSPENSIONE LED 1400 - 82W 24VDC

Code	Color	Led
775519	3 Gold	1 4000°K - 6740 lm
	5 White	6 3000°K - 6576 lm
	9 Black	

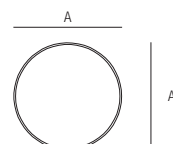

SOSPENSIONE LED 1600 - 94W 24 VDC

Code	Color	Led
775619	3 Gold	1 4000°K - 7740 lm
	5 White	6 3000°K - 7545 lm
	9 Black	

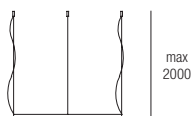

A	Code	Ø	Weight
	775519	Ø 1400	1320gr
	775619	Ø 1600	1480gr
	775719	Ø 1800	1560gr

SOSPENSIONE LED 1800 - 109W 24VDC

Code	Color	Led
775719	3 Gold	1 4000°K - 8960 lm
	5 White	6 3000°K - 8740 lm
	9 Black	

Imballo custom. Chiedere preventivo
Custom packaging. Ask for a quote.

Led CRI >90 IP 40



ESEMPI DI COMPOSIZIONI

Gli elementi a sospensione, di qualsiasi dimensione, possono essere combinati tra loro in base alle proprie esigenze.
Suspensions, of any size, can be combined together to suit your needs.

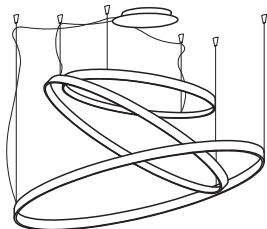

Sospensione a 3 cerchi, 69,8w totale, con scatola alimentazione dimmerabile:
Suspensions composed by 3 circles lamps, 69,8w, with dimmable power supply:

775119 5 - sospensione tonda diametro 390 mm

775219 5 - sospensione tonda diametro 520 mm

775319 5 - sospensione tonda diametro 640 mm

1285+1298 - contenitore con alimentatore max 150w dimmerabile

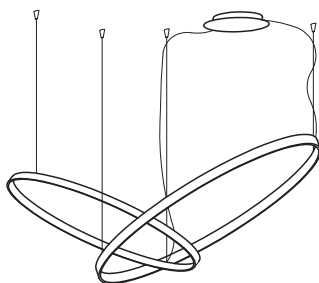

Sospensione a 2 cerchi, 40,8w totale, con scatola alimentazione:
Suspensions composed by 2 circles lamps, 40,8w:

775119 5 - sospensione tonda diametro 390 mm

775219 5 - sospensione tonda diametro 520 mm

1280 - contenitore con alimentatore max 100w

ACCESSORI



CONTENITORE 24VDC 100W max

Code	Color
1280	3 Gold
	5 White
	9 Black

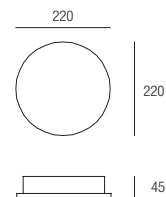

CE IP 20 1430

CONTENITORE 24VDC 150W max

Code	Color
1285	3 Gold
	5 White
	9 Black

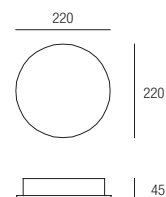

CE IP 20 1465

In fase di ordine specificare il numero dei fori richiesti.
Ordering specify the number of the holes required.

Sospensioni complete di cerchi e rosone con alimentatore.
Suspension complete with circle lamps and canopy with power supply.



A richiesta composizioni personalizzate
Customized compositions on demand.

SOSPENSIONE LED 69,1W 220/240V

Code	Color	Led
776019	3 Gold	1 4000°K - 5690 lm
	5 White	6 3000°K - 5540 lm
	9 Black	

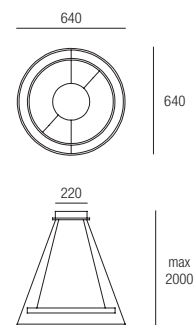

Led CRI 90 CE IP 40 2800

SOSPENSIONE LED 92,5W 220/240V

Code	Color	Led
776119	3 Gold	1 4000°K - 7590 lm
	5 White	6 3000°K - 7390 lm
	9 Black	

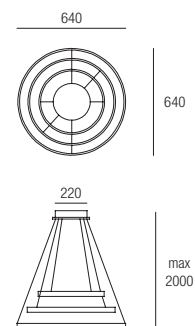

Led CRI 90 CE IP 40 3150







APPLIQUE LED 23,1W 220/240V

Code	Color	Led
776219	3 Gold	1 4000°K - 1900 lm
	5 White	6 3000°K - 1850 lm
	9 Black	

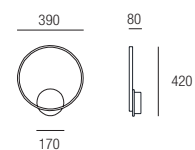

COMPOSIZIONI

Gli elementi a plafone o parete, di qualsiasi dimensione, possono essere combinati tra loro.

La composizione degli elementi deve essere completata con il contenitore con alimentatore appropriato alla potenza totale.

Wall or ceiling elements, of any size, can be combined together to suit your needs. Compositions must be completed with the appropriate box with driver.

APPLIQUE/PLAFONE LED 390 - 23,1W 24 VDC

Code	Color	Led	Distanziali
772119	3 Gold	1 4000°K - 1900 lm	1 mm 70
	5 White	6 3000°K 1850 lm	2 mm 100
	9 Black		3 mm 125

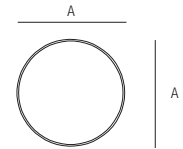

APPLIQUE/PLAFONE LED 520 - 30,7W 24VDC

Code	Color	Led	Distanziali
772219	3 Gold	1 4000°K - 2530 lm	1 mm 70
	5 White	6 3000°K - 2460 lm	2 mm 100
	9 Black		3 mm 125

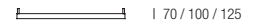

A	Code	Ø	Weight
	772119	Ø 390	460gr
	772219	Ø 520	550gr
	772319	Ø 640	650gr
	772419	Ø 860	710gr

APPLIQUE/PLAFONE LED 640 - 38,4W 24VDC

Code	Color	Led	Distanziali
772319	3 Gold	1 4000°K - 3160 lm	1 mm 70
	5 White	6 3000°K - 3080 lm	2 mm 100
	9 Black		3 mm 125

APPLIQUE/PLAFONE LED 860 - 51,5W 24VDC

Code	Color	Led	Distanziali
772419	3 Gold	1 4000°K - 4230 lm	1 mm 70
	5 White	6 3000°K - 4130 lm	2 mm 100
	9 Black		3 mm 125

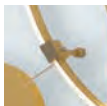

In fase d'ordine precisare la misura del distanziale parete/soffitto

- 1 - mm 70
- 2 - mm 100
- 3 - mm 125

Led CRI >90 IP 40

ACCESSORI



CONTENITORE 24VDC 100W max

Code	Color
1282	3 Gold
	5 White
	9 Black

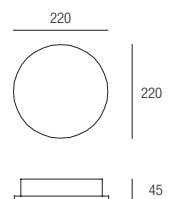

IP 20 1420

CONTENITORE 24VDC 150W max

Code	Color
1286	3 Gold
	5 White
	9 Black

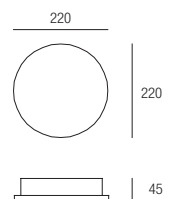

IP 20 1465

In fase di ordine specificare il numero dei fori richiesti.
Ordering specify the number of the holes required.







SOSPENSIONE A SBALZO LED 32,3W 24VDC

Code	Color	Led
773219	3 Gold 5 White 9 Black	1 4000°K - 4982 lm 6 3000°K - 4699 lm

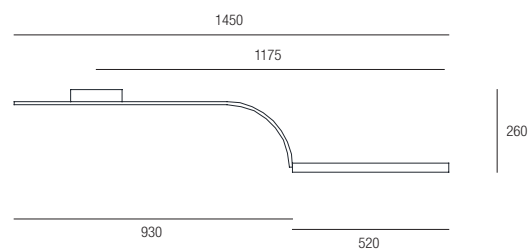

Led CRI 90  CE IP 40      1650

DEGAS

Design Athena

Serie di sospensioni a LED, realizzate in alluminio con finitura bianca, nera, ardesia e grigia. Montate con strip led 19,2w. Scatola alimentazione inclusa.
Series of suspensions lamps LED, made of aluminum with white, black dark grey and grey finishing. Assembled with 19.2w LED strip. Power Supply included.

MISURE/ CUSTOM

Tutte le sospensioni della collezione DEGAS possono essere realizzate con misure personalizzate.
All the hanging and the ceiling lights of the DEGAS collection can be realised with tailored measures.

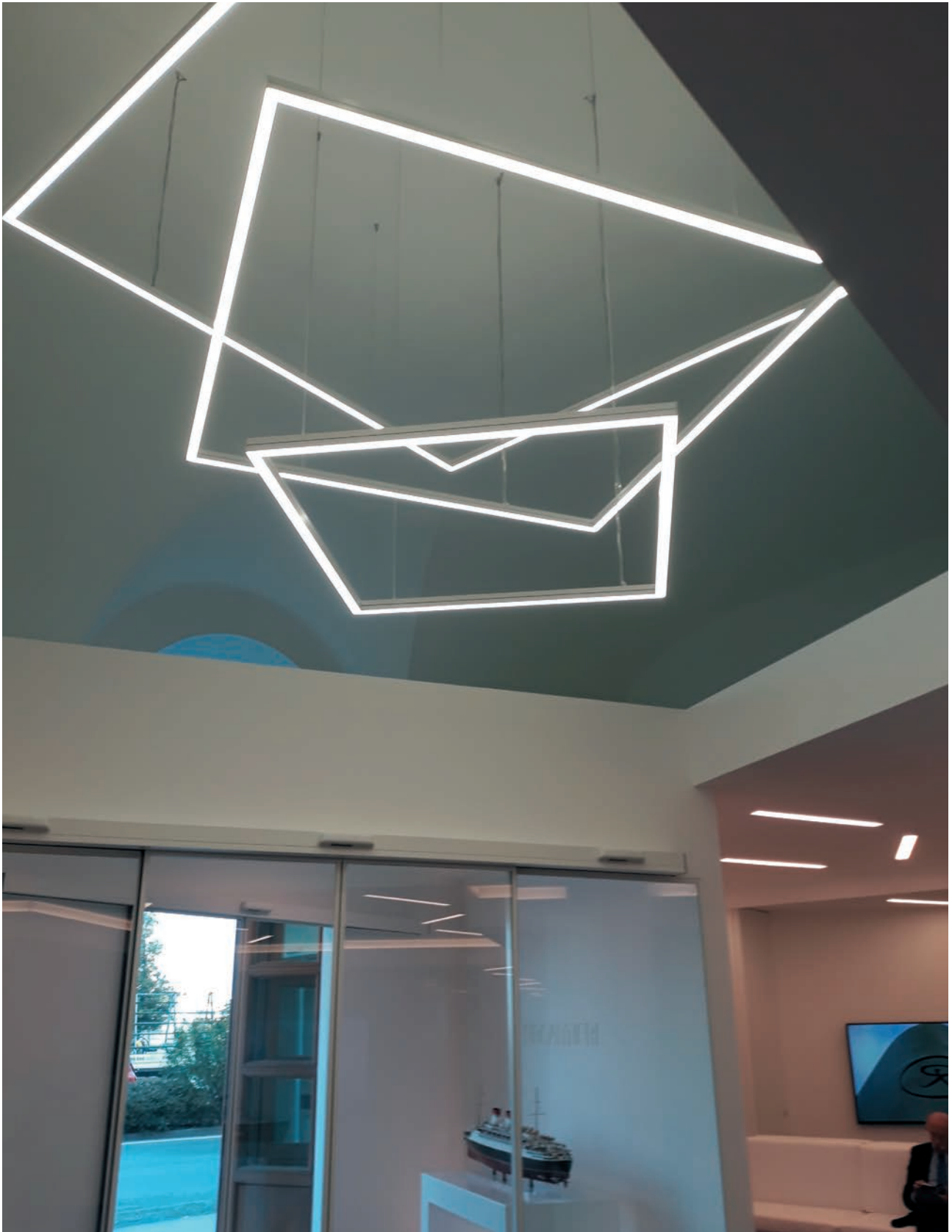



SOSPENSIONE LED 48W 220/240V

Code	Color	Led
905219	5 White	1 4000°K - 3950 lm
	6 Ardesia	6 3000°K - 3850 lm
	7 Grey	
	9 Black	

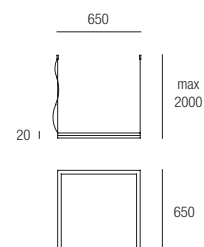

Led CRI 90 IP 20 2410

20

SOSPENSIONE LED 60W 220/240V

Code	Color	Led
905319	5 White	1 4000°K - 4740 lm
	6 Ardesia	6 3000°K - 4620 lm
	7 Grey	
	9 Black	

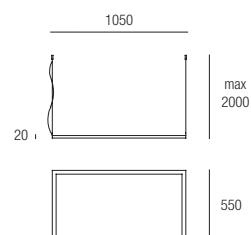

Led CRI 90 IP 20 2790





SOSPENSIONE LED 86W 220/240V

Code	Color	Led
905819	5 White	1 4000°K - 11682 lm
	6 Ardesia	6 3000°K - 11016 lm
	7 Grey	
	9 Black	

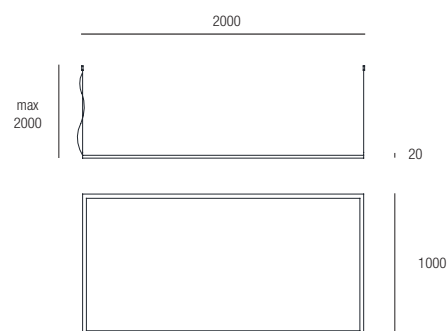

Led CRI 90 IP 20

SOSPENSIONE LED 129W 220/240V

Code	Color	Led
905719	5 White	1 4000°K up 2920 - down 11682
	6 Ardesia	6 3000°K up 2754 - down 11016
	7 Grey	
	9 Black	

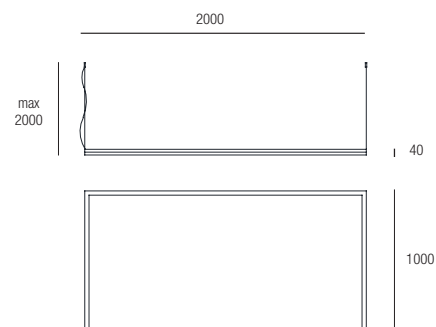

Led CRI 90 IP 20





SOSPENSIONE LED 72W 220/240V

Code	Color	Led
905519	5 White	1 4000°K up 2050 - down 3950
	6 Ardesia	6 3000°K up 2050 - down 3800
	7 Grey	
	9 Black	

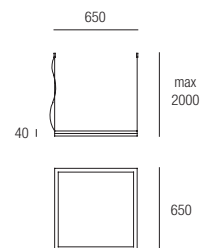

Led CRI 90 IP 20 4410

SOSPENSIONE LED 99W 220/240V

Code	Color	Led
905619	5 White	1 4000°K up 3160 - down 4930
	6 Ardesia	6 3000°K up 3080 - down 4800
	7 Grey	
	9 Black	

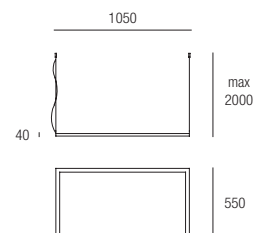

Led CRI 90 IP 20 4700



LAMPADA TERRA LED 48W 220/240V

Code	Color	Led
908019	5 White	1 4000°K - 3950 lm
	6 Ardesia	6 3000°K - 3850 lm
	7 Grey	
	9 Black	

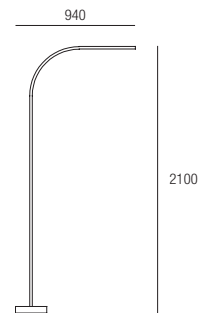

Led CRI 90 IP 20 5620

LAMPADA PARETE CON PULSANTE WIRELESS 38,4W 220/240V

Code	Color	Led
908119	5 White	1 4000°K - 3160 lm
	6 Ardesia	6 3000°K - 3080 lm
	7 Grey	
	9 Black	

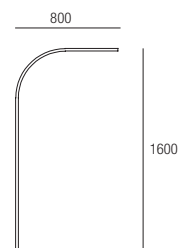







Led CRI 90 IP 20 1620











LAMPADA TERRA LED 48W per lato 220/240V
DIMMERAZIONE INDIPENDENTE SU OGNI LATO CON PUSH

Code	Color	Led
908219	5  White	1  4000°K - 12850 lm
	6  Ardesia	6  3000°K - 12120 lm
	7  Grey	
	9  Black	





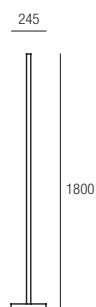

LAMPADA TERRA LED 48W per lato 220/240V
DIMMERAZIONE UNICA DEI DUE LATI CON PUSH WIRELESS

Code	Color	Led
908220	5  White	1  4000°K - 12850 lm
	6  Ardesia	6  3000°K - 12120 lm
	7  Grey	
	9  Black	











LAMPADA TERRA LED 34W per lato 220/240V
DIMMERAZIONE INDIPENDENTE SU OGNI LATO CON PUSH

Code	Color	Led
908619	5  White	1  4000°K - 10276 lm
	6  Ardesia	6  3000°K - 9692 lm
	7  Grey	
	9  Black	

LAMPADA TERRA LED 34W per lato 220/240V
DIMMERAZIONE UNICA DEI DUE LATI CON PUSH WIRELESS

Code	Color	Led
908620	5  White	1  4000°K - 10276 lm
	6  Ardesia	6  3000°K - 9692 lm
	7  Grey	
	9  Black	

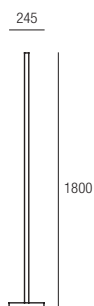

MONET





Design Athena

Collezione di plafoniere e sospensioni realizzate in metallo verniciato. Disponibile nella versione bianco e nero con punti luci Led. La collezione è disponibile anche nella versione con dimmer con funzione di accensione, spegnimento e regolazione tramite push.

Collection of ceiling lamps and suspensions made by painted metal. Available in white and black colour and spotted Leds. The collection is also available with dimmer push controller.





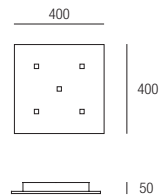

PLAFONIERA LED 400 - 29W 220/240V

Code	Color	Led
8944	5  White	1  4000°K - 3650 lm
	9  Black	6  3000°K - 3400 lm



Led CRI >80   IP 20     2100 



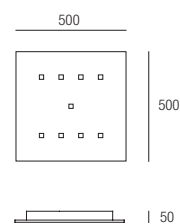

PLAFONIERA LED 500 - 52W 220/240V

Code	Color	Led
8945	5  White	1  4000°K - 6570 lm
	9  Black	6  3000°K - 6120 lm



Led CRI >80   IP 20     2900 



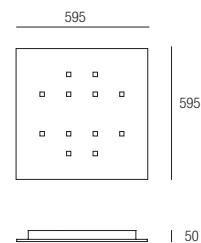

PLAFONIERA LED 600 - 70W 220/240V

Code	Color	Led
8946	5  White	1  4000°K - 8760 lm
	9  Black	6  3000°K - 8160 lm



Led CRI >80   IP 20     4600 

PLAFONIERA LED 1010 - 58W 220/240V

Code	Color	Led
8947	5  White	1  4000°K - 7300 lm
	9  Black	6  3000°K - 6800 lm

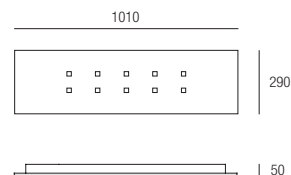

Led CRI >80   IP 20     4600 

SOSPENSIONE LED 400 - 29W 220/240V

Code	Color	Led
8954	5 White	1 4000°K - 3650 lm
	9 Black	6 3000°K - 3400 lm

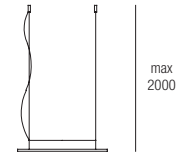
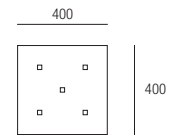

SOSPENSIONE LED BIEMISSIONE 400 - 29W+ UP 12W 220/240V

Predisposta per doppia accensione - con accessorio 1298 accensione unica.

Predisposta per doppia accensione - con accessorio 1298 accensione unica.

Code	Color	Led
8974	5 White	1 4000°K - down 3650 - up 1460 lm
	9 Black	6 3000°K - down 3400 - up 1360 lm



Led CRI >80 IP 20 **8954** **8974**
 2370 2440

SOSPENSIONE LED 500 - 52W 220/240V

Code	Color	Led
8955	5 White	1 4000°K - 6570 lm
	9 Black	6 3000°K - 6120 lm

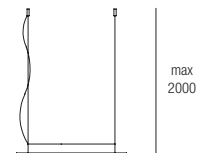
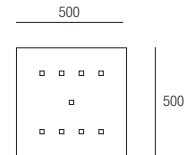

SOSPENSIONE LED BIEMISSIONE 500 - 52W + UP 12W 220/240V

Predisposta per doppia accensione - con accessorio 1299 accensione unica.

Predisposta per doppia accensione - con accessorio 1299 accensione unica.





Code	Color	Led
8975	5 White	1 4000°K - down 6570 lm - up 1460 lm
	9 Black	6 3000°K - down 6120 lm - up 1360 lm



Led CRI >80 IP 20 **8955** **8975**
 3200 3270





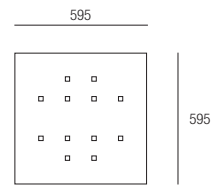

SOSPENSIONE LED 600 - 70W 220/240V

Code	Color	Led
8956	5  White	1  4000°K - 8760 lm
	9  Black	6  3000°K - 8160 lm





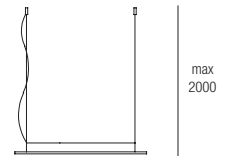

SOSPENSIONE LED BIEMISSIONE 600 - 70W + UP 12W

Code	Color	Led
8976	5  White	1  4000°K - down 8760 lm - up 1000 lm
	9  Black	6  3000°K - down 8160 lm - up 940 lm





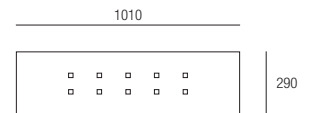

Led CRI >80   IP 20      

SOSPENSIONE LED 1010 - 58W 220/240V

Code	Color	Led
8957	5  White	1  4000°K - 7300 lm
	9  Black	6  3000°K - 6800 lm



SOSPENSIONE LED BIEMISSIONE 1010 - 58W + UP 12W

Code	Color	Led
8977	5  White	1  4000°K - down 7300 lm - up 1460 lm
	9  Black	6  3000°K - down 6800 lm - up 1360 lm



Led CRI >80   IP 20      



PICASSO

Design Athena

Collezione di applique disponibili in 3 misure con biemissione o monoemissione.

La vasta gamma di colori della collezione ne permette l'utilizzo in ambienti commerciali, lavorativi e domestici e in contesti sia moderni che classici.

Collection of wall lamp available in 3 sizes with bidirectional or unidirectional light.

The wide range of colors of the collection allows the use in commercial, business and domestic contexts in both modern and classic.





APPLIQUE LED 3X4,5W 220/240V



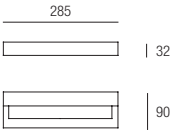



Code	Color	Led
88611	1 Chrome	1 4000°K - 1860 lm
	3 Gold	6 3000°K - 1785 lm
	4 Corten	
	5 White	



APPLIQUE LED UP 3x4,5W DOWN 1x4,5W 220/240V





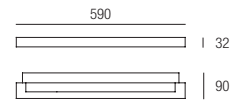

Code	Color	Led
88612	1 Chrome	1 4000°K up 1860 lm down 620 lm
	3 Gold	6 3000°K up 1785 lm down 595 lm
	4 Corten	
	5 White	

APPLIQUE LED 1x10W 220/240V

Code	Color	Led
88621	1  Chrome	1  4000°K - 1445 lm
	3  Gold	6  3000°K - 1360 lm
	4  Corten	
	5  White	
		









APPLIQUE LED 2x10W 220/240V

Code	Color	Led
88622	1  Chrome	1  4000°K - 1445+1445 lm
	3  Gold	6  3000°K - 1360+1360 lm
	4  Corten	
	5  White	
		







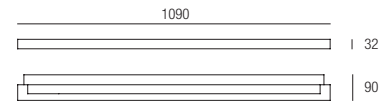

 Led CRI 90   IP 20    
 88621 88622
 1230 1270

APPLIQUE LED 1x19,5W 220/240V

Code	Color	Led
88631	1  Chrome	1  4000°K - 3000 lm
	3  Gold	6  3000°K - 2830 lm
	4  Corten	
	5  White	
		



APPLIQUE LED 2x19,5W 220/240V

Code	Color	Led
88632	1  Chrome	1  4000°K - 3000+3000 lm
	3  Gold	6  3000°K - 2860+2860 lm
	4  Corten	
	5  White	
		



 Led CRI 90   IP 20    
 88631 88632
 2390 2760



BETA

Design Athena

Collezione di faretto, applique e lampada da tavolo a led, realizzate in metallo con faretto orientabili o con flessibile. La tecnologia Led per illuminare e valorizzare sia ambienti lavorativi che abitativi e per camere di hotel.

Collection of metal spotlights, wall lamps and LED table lamps with adjustable spotlights or flexible arms. LED technology for lighting and enhancing both workplaces and homes and hotel's room.



LAMPADA TAVOLO LED 1x2W 220/240V - FLEX MM 500

Code	Color	Led
8530	1 Chrome	1 4000/4500°K - 150 lm
	2 Nickel	6 3000/3200°K - 150 lm

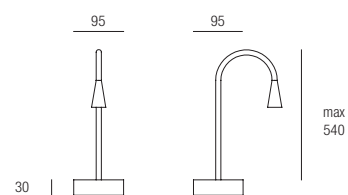



APPLIQUE LED 1x2W 220/240V - FLEX MM 350

Code	Color	Led
8501	1 Chrome	1 4000/4500°K - 150 lm
	2 Nickel	6 3000/3200°K - 150 lm

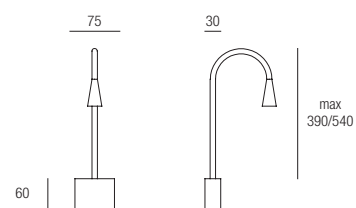

APPLIQUE LED 1x2W 220/240V - FLEX MM 500

Code	Color	Led
8511	1 Chrome	1 4000/4500°K - 150 lm
	2 Nickel	6 3000/3200°K - 150 lm



CE IP 40 **8501** **8511**
340 370

FARETTO LED 1x2W 220/240V

Code	Color	Led
8301	1 Chrome	1 4000/4500°K - 150 lm
	2 Nickel	6 3000/3200°K - 150 lm

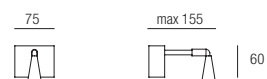

A richiesta fornibili anche con attacco diretto alle testate dei letti.
Under request, they can be supplied also with a direct attachment to the headboards of the beds.

CE IP 40 **8301**
250

INCASSO

ORIONE
PEGASO

incasso



ORIONE

Design Athena

Faretto da incasso fisso per interno con corpo in ottone. Completo di molle per installazione.
 Indoor fixed recessed metal spot light. Copper structure. Springs included.

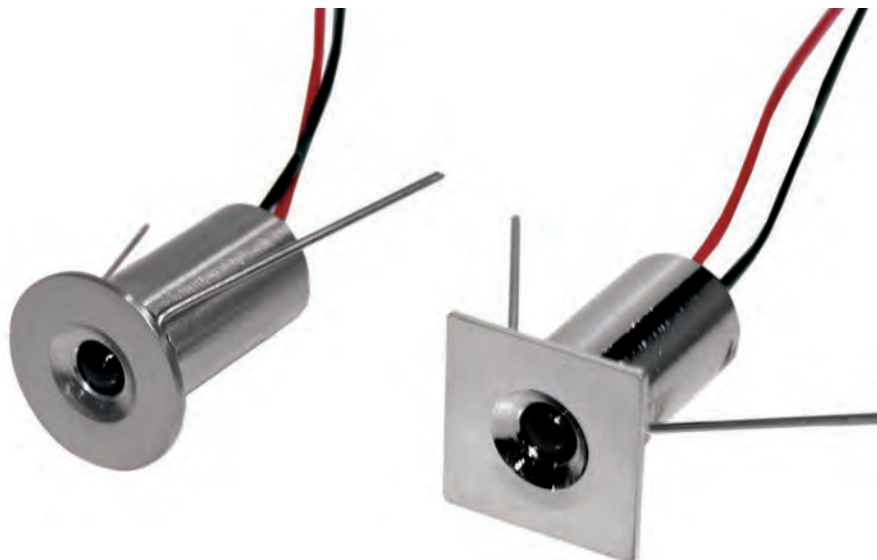

Collegamento in parallelo.
 Parallel connection.

FARETTO INCASSO TONDO LED 1x0,5W - 24Vdc 20mA

Code	Color	Led	Optic
11301	1 Chrome	1 Natural White	120°
	2 Nickel	6 Warm White	
	5 White	2 Blue	
		4 Green	
		8 Red	
		9 RGB	

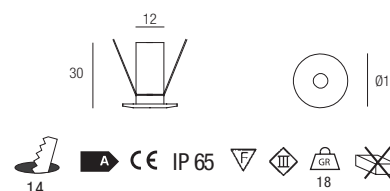

FARETTO INCASSO QUADRO LED 1x0,5W - 24Vdc 20mA

Code	Color	Led	Optic
11311	1 Chrome	1 Natural White	120°
	2 Nickel	6 Warm White	
	5 White	2 Blue	
		4 Green	
		8 Red	
		9 RGB	

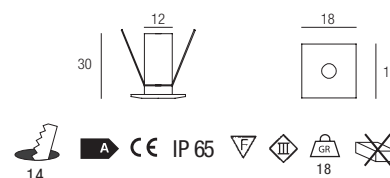

DRIVERS

Utilizzare alimentatori 24Vdc pag 311
 Use DRIVERS 24Vdc page 311

ACCESSORI

1130
 Cassaforma + OR
 Mould + OR

Ø 16x35
 4



Faretto ad incasso fisso per interno/esterno, completo di molle per controsoffitto e cavo FROR cm.50.
Corpo in alluminio anodizzato, ghiera in ottone o acciaio AISI 316. Vetro temprato satinato. Calpestabile.

Indoor/outdoor fixed recessed spot light. Ceiling springs and wire FROR cm 50 included. Aluminium structure, copper or Steel AISI 316 front piece.
Tempered satin glass. Walkable.



Collegamento in serie.
Serial connection.

Se interrati, prevedere un drenaggio con ghiaia di circa 20/30 cm.
Utilizzare esclusivamente cavi ed accessori con grado di protezione per uso esterno.
If underground, provide a drainage with gravel 20/30 cm height. Use only outdoor protection wires accessories.

FARETTO INCASSO TONDO LED 1x1W - 350mA 100 lm

Code	Color	Led	Optic
11302	1 Chrome	1 4000/4500°K	3 120° satinato
	2 Nickel (uso interno)	6 3000/3200°K	
	5 White (uso interno non calpestabile)		
11342	6 Steel		



FARETTO INCASSO QUADRO LED 1x1W - 350mA 100 lm

Code	Color	Led	Optic
11312	1 Chrome	1 4000/4500°K	3 120° satinato
	2 Nickel (uso interno)	6 3000/3200°K	
	5 White (uso interno non calpestabile)		
11352	6 Steel		



DRIVERS

Utilizzare alimentatori 350mA pag 310
Use DRIVERS 350mA page 310

ACCESSORI

1140

Ghiera
Ferrule



ACCESSORI

1131

Cassaforma + OR
Mould + OR



Faretto ad incasso fisso per interno/esterno, completo di molle per controsoffitto e cavo FROR cm.50.
 Corpo in alluminio anodizzato, ghiera in ottone o acciaio AISI 316. Vetro temprato satinato. Calpestabile.
 Indoor/outdoor fixed recessed spot light. Ceiling springs and wire FROR cm 50 included. Aluminium structure, copper or Steel AISI 316 front piece.
 Tempered satin glass. Walkable.



Collegamento in serie.
 Serial connection.

Se interrati prevedere un drenaggio di circa 20/30 cm.
 Utilizzare esclusivamente cavi ed accessori con grado di protezione per uso esterno.
 If underground provide a drainage with gravel 20/30 cm. height. Use only outdoor protection wires accessories.

FARETTO INCASSO TONDO LED 1x1W - 350mA 100 lm
1x2W - 500mA 150 lm

Code	Color	Led	Optic
11303	1 Chrome	1 4000/4500°K	1 25° trasparente
	2 Nickel (uso interno)	6 3000/3200°K	2 40° trasparente
	5 White (uso interno non calpestabile)		3 120° satinato
11343	6 Steel		

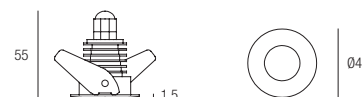

FARETTO INCASSO QUADRO LED 1x1W - 350mA 100 lm
1x2W - 500mA 150 lm

Code	Color	Led	Optic
11313	1 Chrome	1 4000/4500°K	1 25° trasparente
	2 Nickel (uso interno)	6 3000/3200°K	2 40° trasparente
	5 White (uso interno non calpestabile)		3 120° satinato
11353	6 Steel		

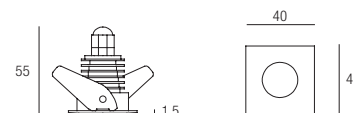

DRIVERS

Utilizzare alimentatori 350-500mA pag 310
 Use DRIVERS 350-500mA page 310

ACCESSORI

1132
 Cassaforma + OR
 Mould + OR

Ø 62x95
 4



Faretto ad incasso fisso per interno/esterno, completo di molle per controsoffitto e cavo FROR cm.50.

Corpo in alluminio anodizzato, ghiera in ottone o acciaio AISI 316. Vetro temprato satinato. Calpestabile.

Indoor/outdoor fixed recessed spot light. Ceiling springs and wire FROR cm 50 included. Aluminium structure, copper or Steel AISI 316 front piece. Tempered satin glass. Walkable.



Collegamento in serie.
Serial connection.

Se interrati, prevedere un drenaggio con ghiaia di circa 20/30 cm.

Utilizzare esclusivamente cavi ed accessori con grado di protezione per uso esterno.

If underground, provide a drainage with gravel 20/30 cm height. Use only outdoor protection wires accessories.

FARETTO INCASSO TONDO LED 1x1W - 350mA 100 lm
1x2W - 500mA 150 lm
1x3W - 700mA 200 lm

Code	Color	Led	Optic
11304	1 Chrome	1 4000/4500°K	1 25° trasparente
	2 Nickel (uso interno)	5 5000/5500°K	2 40° trasparente
	5 White (uso interno non calpestabile)	6 3000/3200°K	3 120° satinato
		9 RGB 350 mA	

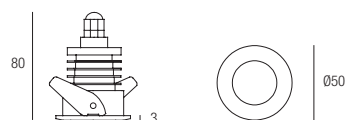

11344	6 Steel		
-------	---------	--	--



FARETTO INCASSO TONDO LED 1x4,5W - 240mA

Code	Color	Led	Optic
11324	1 Chrome	1 4000°K - 400 lm	3 120° satinato
	2 Nickel (uso interno)	6 3000°K - 360 lm	
	5 White (uso interno non calpestabile)		

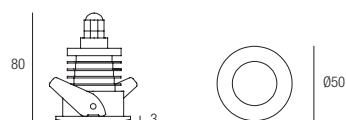

DRIVERS

Utilizzare alimentatori 350-500-700mA pag 310
Use DRIVERS 350-500-700mA page 310

ACCESSORI

1133
Cassaforma + OR
Mould + OR

Ø 62x95



Faretto ad incasso fisso per interno/esterno, completo di molle per controsoffitto e cavo FROR cm.50.
 Corpo in alluminio anodizzato, ghiera in ottone o acciaio AISI 316. Vetro temprato satinato. Calpestabile.
 Indoor/outdoor fixed recessed spot light. Ceiling springs and wire FROR cm 50 included. Aluminium structure, copper or Steel AISI 316 front piece.
 Tempered satin glass. Walkable.



Collegamento in serie.
 Serial connection.

Se interrati, prevedere un drenaggio con ghiaia di circa 20/30 cm.
 Utilizzare esclusivamente cavi ed accessori con grado di protezione per uso esterno.
 If underground, provide a drainage with gravel 20/30 cm height. Use only outdoor protection wires accessories.

FARETTO INCASSO QUADRO LED 1x1W - 350mA 100 lm
1x2W - 500mA 150 lm
1x3W - 700mA 200 lm

Code	Color	Led	Optic
11314	1 Chrome 2 Nickel (uso interno) 5 White (uso interno non calpestabile)	1 4000/4500°K 5 5000/5500°K 6 3000/3200°K 9 RGB 350 mA	1 25° trasparente 2 40° trasparente 3 120° satinato
11354	6 Steel		

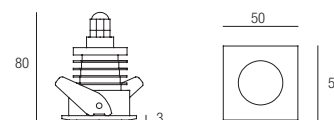

FARETTO INCASSO QUADRO LED 1x4,5W - 240mA

Code	Color	Led	Optic
11334	1 Chrome 2 Nickel (uso interno) 5 White (uso interno non calpestabile)	1 4000°K - 400 lm 6 3000°K - 360 lm	3 120° satinato

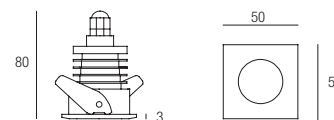

DRIVERS

Utilizzare alimentatori 350-500-700mA pag 310
 Use DRIVERS 350-500-700mA page 310

ACCESSORI

1133
 Cassaforma + OR
 Mould + OR

 5 Ø 62x95



Faretto fisso da incasso in metallo. Applicazione con molle per controsoffitto.
Fixed recessed metal spotlight. Application with springs for false ceiling.



Collegamento in serie.
Serial connection.

FARETTO INCASSO TONDO 1x1W - 350mA

Code	Color	Led	Optic
11481	1 Chrome 2 Nickel 5 Matt White	1 4000/4500°K - 135lm 2 Blue 5 5000/7000°K - 155lm 6 2700/3500°K - 145lm 8 Red	1 180°



FARETTO INCASSO QUADRATO 1x1W - 350 mA

Code	Color	Led	Optic
11491	1 Chrome 2 Nickel 5 Matt White	1 4000/4500°K - 135lm 2 Blue 5 5000/7000°K - 155lm 6 2700/3500°K - 145lm 8 Red	1 180°

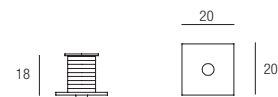

DRIVERS

Utilizzare alimentatori 350mA pag 310
Use DRIVERS 350mA page 310

ACCESSORI

1150
Accessorio per fissaggio spot su spessori fino a 5 mm
Fitting to fix spot on max 5 mm thickness



Faretto orientabile da incasso in metallo. Corpo faretto in ottone, ghiera in metallo. Applicazione con molle per controsoffitto.
Adjustable recessed metal spotlight. Copper structure, metal front piece. Application with springs for false ceiling.



Collegamento in serie.
Serial connection.

FARETTO INCASSO TONDO LED **1x1W - 350mA 100lm**
1x2W - 500mA 150lm
1x3W - 700mA 200lm

Code	Color	Led	Optic
11501	1 Chrome	1 4000/4500°K	2 40° trasparente
	2 Nickel (uso interno)	6 3000/3200°K	3 120° satinato
	5 Matt White (uso interno)	9 RGB 350 mA	3 120° satinato

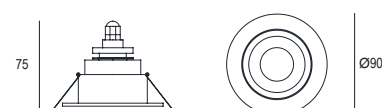

FARETTO INCASSO QUADRO LED **1x1W - 350mA 100lm**
1x2W - 500mA 150lm
1x3W - 700mA 200lm

Code	Color	Led	Optic
11511	1 Chrome	1 4000/4500°K	2 40° trasparente
	2 Nickel (uso interno)	6 3000/3200°K	3 120° satinato
	5 Matt White (uso interno)	9 RGB 350 mA	3 120° satinato



DRIVERS

Utilizzare alimentatori 350/500/700mA pag 310
Use DRIVERS 350/500/700mA page 310

Faretto fisso da incasso in metallo. Corpo faretto in ottone, ghiera in metallo. Applicazione con molle per controsoffitto.
Fixed recessed metal spotlight. Copper structure, metal front piece. Application with springs for false ceiling.



Collegamento in serie.
Serial connection.

FARETTO INCASSO TONDO LED **1x1W - 350mA 100lm**
1x2W - 500mA 150lm
1x3W - 700mA 200lm

Code	Color	Led	Optic
11521	1 Chrome	1 4000/4500°K	2 40° trasparente
	2 Nickel (uso interno)	6 3000/3200°K	3 120° satinato
	5 Matt White (uso interno)	9 RGB 350 mA	3 120° satinato



FARETTO INCASSO QUADRO LED **1x1W - 350mA 100lm**
1x2W - 500mA 150lm
1x3W - 700mA 200lm

Code	Color	Led	Optic
11531	1 Chrome	1 4000/4500°K	2 40° trasparente
	2 Nickel (uso interno)	6 3000/3200°K	3 120° satinato
	5 Matt White (uso interno)	9 RGB 350 mA	3 120° satinato



DRIVERS

Utilizzare alimentatori 350/500/700mA pag 310
Use DRIVERS 350/500/700mA page 310

PEGASO

Design Athena

Faretto incasso orientabile. Corpo in metallo.
Adjustable recessed metal downlight.



FARETTO 90 TONDO ORIENTABILE 220/240V GU10 Led Ø50

Code	Color
1008	<ul style="list-style-type: none"> 1 Chrome 2 Nickel 5 Matt White 9 Black

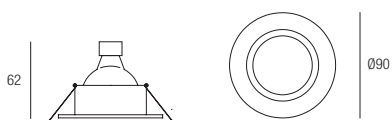

FARETTO 90 QUADRATO ORIENTABILE 220/240V GU10 Led Ø50

Code	Color
1038	<ul style="list-style-type: none"> 1 Chrome 2 Nickel 5 Matt White 9 Black

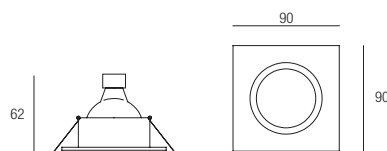

Faretto incasso fisso. Corpo in metallo.
Fixed recessed metal spot light.



FARETTO 80 TONDO FISSO 220/240V GU10 Led Ø50

Code	Color
1010	1 Chrome
	2 Nickel
	5 Matt White
	9 Black

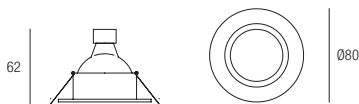

FARETTO 80 QUADRATO FISSO 220/240V GU10 Led Ø50

Code	Color
1040	1 Chrome
	2 Nickel
	5 Matt White
	9 Black

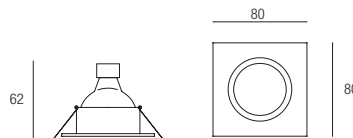

Faretto incasso orientabile. Corpo in metallo.
Adjustable recessed metal downlight.



FARETTO 70 TONDO ORIENTABILE
220/240V GU10 Led Ø35

Code	Color
1011	1 Chrome
	2 Nickel
	5 Matt White
	9 Black

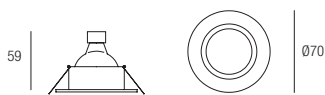

FARETTO 70 QUADRATO ORIENTABILE
220/240V GU10 Led Ø35

Code	Color
1041	1 Chrome
	2 Nickel
	5 Matt White
	9 Black

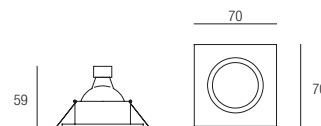

ACCESSORI

DRIVERS
CENTRALINE

Accessori

DRIVERS

Design Athena

DRIVERS CLASSE II

Alimentatori elettronici per power Led 140-240-350-500-700 mA - Collegamento in serie.
Electronic DRIVERS for power Led 140-240-350-500-700 mA - Serial connection.



CODICE	SPECIFICHE	OUTPUT	VOLT	WATT	MISURA	
1261		140mA	45v	max 6w	118x33x19	CE IP 20
1263		240mA	45v	max 10w	118x33x19	CE IP 20
1179	Multipower	250/700mA	6-48v	11-21w	138x40x29	CE IP 20
1172		500mA	24v	max 10w	70x42x20	CE IP 20
1251		700mA	12v	max 8,4w	72x41x14	CE IP 20

Alimentatori elettronici per power Led DIMMERABILI con push 350-500-700 mA - Collegamento Led in serie.
Dimmable electronic DRIVERS for power Led 350-500-700 mA - Serial Connection.



CODICE	SPECIFICHE	OUTPUT	VOLT	WATT	MISURA	
1178	Sincronizzazione automatica con Push. Max 16 pezzi	250/700mA	0-10v Push	21-42w	103x68x30	CE IP 20

Alimentatori elettronici per power Led 350-700 mA - Collegamento Led in serie - IP67.
Electronic DRIVERS for power Led 350-700 mA - Serial Connection - IP67.



CODICE	SPECIFICHE	OUTPUT	VOLT	WATT	MISURA	
1258	IP67	350mA	48v	3-15w	140x30x22	CE IP 67
1259	IP67	700mA	25v	7-15w	140x30x22	CE IP 67

Centralina Dimmer RGB- RGBW per power led 350-1200 mA.
Electronic RGB-RGBW control unit for power led 350-1200 mA.

CODICE	SPECIFICHE	OUTPUT	VOLT	WATT	MISURA	
1313	RGB+RGBW (SLAVE) Wireless	350-1200 mA 350 mA 700 mA	10-42v 10-42v	3,5-14,5w 7-29w	175x45x28	CE IP 20
1314	RGB+RGBW telecomando Wireless	350-1200 mA 350 mA 700 mA	3-45v 10-42v 10-42v	7-15w 3,5-14,5w 7-29w	175x45x28	CE IP 20

Per la scelta degli alimentatori, dopo aver calcolato l'assorbimento totale degli apparecchi da installare, aggiungere circa il 10/15 % di margine in più.
For the choice of DRIVERS, after calculating the total absorption of the equipment to install, add about 10/15 % power more.

DRIVERS 24VDC CLASSE II

Alimentatori elettronici per Led 24Vdc - Collegamento Led in parallelo.
Electronic DRIVERS for Led 24 Vdc - Parallel Led connection.

CODICE	SPECIFICHE	VOLT	WATT	MISURA					
1172		24v	max 10w	70x42x20	CE	IP 20			45
1183		24v	max 20w	103x32x16	CE	IP 20			65
1169		24v	max 50w	165x41x28	CE	IP 20			166
1184		24v	max 75w	225x60x36	CE	IP 20			290
1201	SLIM	24v	max 75w	305x30x17	CE	IP 20			152
1182		24v	max 100w	128x67x33	CE	IP 20			188
1185		24v	max 150w	207x76x35	CE	IP 20			300
1181	SLIM	24v	max 150w	330x30x23	CE	IP 20			255
1180		24v	max 200w	207x76x35	CE	IP 20			380

DRIVERS 24VDC CLASSE II

Alimentatori elettronici per Led 24Vdc - Collegamento Led in parallelo.
Electronic DRIVERS for Led 24 Vdc - Parallel Led connection.

CODICE	SPECIFICHE	VOLT	WATT	MISURA					
1240	IP67	24v	max 20w	118x35x26	CE	IP 67			208
1241	IP67	24v	max 35w	148x40x30	CE	IP 67			307
1242	IP67	24v	max 60w	163x43x32	CE	IP 67			384
1246	IP65	24v	max 60w	100x77x22	CE	IP 65			288
1243	IP67	24v	max 100w	190x52x37	CE	IP 67			615
1247	IP65	24v	max 100w	100x77x22	CE	IP 65			304
1245	IP67	24v	max 150w	190x52x37	CE	IP 67			615
1248	IP65	24v	max 150w	100x77x29	CE	IP 65			373
1171	IP65	24v	max 240w	244x71x37	CE	IP 65			1090















Per la scelta degli alimentatori, dopo aver calcolato l'assorbimento totale degli apparecchi da installare, aggiungere circa il 10/15 % di margine in più.
For the choice of DRIVERS, after calculating the total absorption of the equipment to install, add about 10/15 % power more.

DRIVERS

Design Athena









DRIVERS DIMMERABILI 24VDC CLASSE II

Alimentatori elettronici dimmerabili per power Led 24Vdc - Collegamento Led in parallelo.
Electronic DRIVERS dimmable for Led 24Vdc - Parallel Led connection.

CODICE	DIMMERAZIONE	VOLT	WATT	MISURA	
1165	AC/PUSH-RF WIRELESS	24v	75w	180x56x30	CE IP 20    260
1200	AC/PUSH-DALI	24v	100w	192x60x22	CE IP 20    217
1166	AC/PUSH-DALI	24v	150w	170x50x31	CE IP 65    405
1167	1-10v & PUSH PWM POTENZIOMETRO	24v	240w	219x63x36	CE IP 67    1130
1168	DALI	24v	240w	219x63x36	CE IP 67    1130









DRIVERS DIMMERABILI 24VDC TRIAC

Alimentatori elettronici dimmerabili per power Led 24Vdc - Collegamento Led in parallelo.
Electronic DRIVERS dimmable for Led 24Vdc - Parallel Led connection.

CODICE	DIMMERAZIONE	VOLT	WATT	MISURA	
1161	TRIAC taglio di fase IGBT - MOSFET	24v	60w	175x50x31	CE IP 65    416
1162	TRIAC taglio di fase AC/PUSH	24v	75w	180x56x30	CE IP 20    260
1164	TRIAC taglio di fase AC/PUSH	24v	150w	235x67x36	CE IP 20    297

DRIVERS 24V DC CON CONTENITORE

Contenitori in metallo completi di alimentatori elettronici per Led 24vdc - Collegamento Led in parallelo.
Metal boxes with electronic DRIVERS for 24Vdc Led. Parallel Led connection.

CODICE			VOLT	WATT	MISURA				
1187	5	White	24v	20w	200x50x35	CE	IP 20	⊕	440
1187	7	Grey							
1187	9	Black							
									
1197	5	White	24v	50w	230x83x35	CE	IP 20	⊕	490
1197	7	Grey							
1197	9	Black							
									
1188	5	White	24v	75w	260x80x45	CE	IP 20	⊕	740
1188	7	Grey							
1188	9	Black							
									
1199	5	White	24v	60w	130x130x41	CE	IP 20	⊕	810
1199	6	Ardesia							
1199	7	Grey							
1199	9	Black							
									
1256	5	White	24v	100w	142x182x41	CE	IP 20	⊕	1030
1256	6	Ardesia							
1256	7	Grey							
1256	9	Black							
									
1257	5	White	24v	150w	230x127x52	CE	IP 20	⊕	1210
1257	6	Ardesia							
1257	7	Grey							
1257	9	Black							
									
1270	5	White	24v	200w	230x127x52	CE	IP 20	⊕	1280
1270	6	Ardesia							
1270	7	Grey							
1270	9	Black							
									
1271	5	White	24v	2x100w	262x162x50	CE	IP 20	⊕	1150
1271	7	Grey							
1271	9	Black							
									
1272	5	White	24v	2x150w	262x162x50	CE	IP 20	⊕	1150
1272	7	Grey							
1272	9	Black							
									

CENTRALINE ON/OFF DIMMER PER ALIMENTATORI 24 VDC

Centralina elettronica ON/OFF DIMMER per led 24Vdc da utilizzare con alimentatori 24Vdc.
Electronic control unit ON/OFF DIMMER for led 24Vdc to be used with 24Vdc power supply units.

CODICE	SPECIFICHE	DIMMERAZIONE	WATT	MISURA	
1260	3 canali 3,3a –80w cad MASTER Sincro: master senza carichi	DALI 0-10v AC/CV/PUSH	3x80w	138x40x28	CE IP 20  
1300	MASTER/SLAVE	PUSH 0-10v 1-10v	240w	56x68x35	CE IP 20  
1303		CASAMBI PUSH	240w	56x68x35	CE IP 20  
1304		DALI 0-10v 1-10v PUSH	240w	56x68x35	CE IP 20  
1306	1 canale 8A MASTER/SLAVE - WIRELESS Sincro: master senza carichi	PUSH	190w	97x33x18	CE IP 20  
1308	1 canale 8A MASTER WIRELESS Sincro: master senza carichi	RF - PUSH + telecomando 4 zone	190w	97x33x18	CE IP 65  
1309	1 canale 8A MASTER WIRELESS Sincro: master senza carichi	RF - PUSH + pulsante wireless	190w	97x33x18	CE IP 65  
1311	2 canali 5A –120w cad MASTER/SLAVE - WIRELESS Sincro: master senza carichi	RF - PUSH APP TUYA ALEXA AMAZON ECHO	2x120w	97x33x18	CE IP 67  

AMPLIFICATORI DI SEGNALE PWM

CODICE		WATT	MISURA	
1262		240w	138x40x29	CE IP 20  

CENTRALINE PER RGB/WHITE - DYNAMIC (CCT)

Centralina elettronica per Led 24Vdc da utilizzare con alimentatori 24Vdc.
Electronic Drivers for Led 24Vdc. Use with Drivers 24Vdc.



CODICE	SPECIFICHE	DIMMERAZIONE	WATT	MISURA	
1227	RGB - RGB/W 4 canali 2,5A 60w cad Sincro: master senza carichi	TELECOMANDO RF	240w	75x65x20	CE IP 20   135
1305	RGB	PUSH	150w	56x68x35	CE IP 20   40
1311	CCT 2 canali 5A - 120w cad MASTER/SLAVE Wireless Sincro: master senza carichi	RF PUSH (2 CH) APP TUYA ALEXA AMAZON ECHO	2x120w	97x33x18	CE IP 20   43
1312	CCT 4 canali 3A 72w cad MASTER/SLAVE Wireless Sincro: master senza carichi	RF PUSH (2 CH) APP TUYA ALEXA AMAZON ECHO	4x72w	97x33x18	CE IP 20   43

AMPLIFICATORI DI SEGNALE RGB-RGBW

CODICE	SPECIFICHE	WATT	MISURA	
1267	RGB - RGBW 4 canali 3A 72w cad	288w	150x75x35	CE IP 20   250
1262	RGB	240w	138x40x29	CE IP 20   130

ALIMENTATORI/CENTRALINE PER RGB-RGB/W

Centralina elettronica RGB completa di alimentatore per Led 24Vdc.
Electronic Drivers/control unit for 24Vdc - max 120W.

CODICE	SPECIFICHE	DIMMERAZIONE	WATT	MISURA	
1228	RGB 3 canali 1,38A 33w cad RGBW 4 canali 1,04A 24w cad	PUSH DMX DALI	96w	207x76x35	CE IP 20    300

UNITÀ EMERGENZA

Unità di emergenza (1h) da utilizzare con alimentatori adeguati.
Emergency unit (1h). Use with appropriate DRIVERS.

CODICE	SPECIFICHE	MISURA	
1250	UNITA' DI EMERGENZA + BATTERIA	125x45x23 batteria 218x40x28,5 unità emerg.	CE IP 20   430

INDICE E CODICI

Design Athena

0200	Focus300-160	pag. 140-148	063115	Twin	pag. 167
0202	Focus300-160	pag. 140-148	0635	Twin	pag. 168
0203	Focus300-160-Twin	pag. 140-148-170	063515	Twin	pag. 168
0204	Focus300-160	pag. 140-148	0639	Twin	pag. 169
0205	Focus300-160	pag. 140-148	063915	Twin	pag. 169
0206	Focus300-160	pag. 140-148	0640	Twin	pag. 169
0207	Focus300-160	pag. 140-148	064015	Twin	pag. 169
0208	Focus300-160	pag. 141-149	0644	Twin	pag. 168
0208	Twin	pag. 170	064415	Twin	pag. 168
0209	Focus300-160	pag. 141-149	0646	Twin	pag. 168
0210	Focus300-160	pag. 141-149	064615	Twin	pag. 168
0211	Focus300	pag. 139	0647	Twin	pag. 167
0214	Focus300-160	pag. 141-149	064715	Twin	pag. 167
0234	Focus300	pag. 138	0648	Twin	pag. 167
0240	Focus300	pag. 135	064815	Twin	pag. 167
0251	Focus300	pag. 138	0649	Twin	pag. 169
0272	Focus300	pag. 137	064915	Twin	pag. 169
0282	Focus300	pag. 137	1008	Pegaso	pag. 305
0289	Focus300	pag. 131	1010	Pegaso	pag. 306
0290	Focus300	pag. 133	1011	Pegaso	pag. 307
0319	Twin	pag. 170	1038	Pegaso	pag. 305
0328	Twin	pag. 170	1040	Pegaso	pag. 306
0329	Twin	pag. 170	1041	Pegaso	pag. 307
0330	Twin	pag. 170	1130	Orione	pag. 297
0331	Twin	pag. 170	11301	Orione	pag. 297
0335	Twin	pag. 171	11302	Orione	pag. 298
0336	Twin	pag. 171	11303	Orione	pag. 299
0338	Twin	pag. 171	11304	Orione	pag. 300
0340	Twin	pag. 171	1131	Orione	pag. 298
0341	Twin	pag. 171	11311	Orione	pag. 297
0353	Twin	pag. 158	11312	Orione	pag. 298
0354	Twin	pag. 161	11313	Orione	pag. 299
0355	Twin	pag. 159	11314	Orione	pag. 301
0357	Twin	pag. 151	1132	Orione	pag. 299
0358	Twin	pag. 153	11324	Orione	pag. 300
0360	Twin	pag. 154	1133	Orione	pag. 300-301
0361	Twin	pag. 155	11334	Orione	pag. 301
0362	Twin	pag. 155	11342	Orione	pag. 298
0363	Twin	pag. 157	11343	Orione	pag. 299
0434	Focus160	pag. 147	11344	Orione	pag. 300
0435	Focus160	pag. 147	11352	Orione	pag. 298
0457	Focus160	pag. 143	11353	Orione	pag. 299
0458	Focus160	pag. 144	11354	Orione	pag. 301
0472	Focus160	pag. 146	1140	Orione	pag. 298
0490	Focus160	pag. 145	11481	Orione	pag. 302
0631	Twin	pag. 167	11491	Orione	pag. 302

11501	Orione	pag. 303	1259	Alimentatori	pag. 310
11511	Orione	pag. 303	1260	Alimentatori	pag. 314
11521	Orione	pag. 304	1261	Alimentatori	pag. 310
11531	Orione	pag. 304	1262	Alimentatori	pag. 314-315
1161	Alimentatori	pag. 312	1263	Alimentatori	pag. 310
1162	Alimentatori	pag. 312	1267	Alimentatori	pag. 315
1163	Alimentatori	pag. 312	1270	Alimentatori	pag. 313
1164	Alimentatori	pag. 312	1271	Alimentatori	pag. 313
1165	Alimentatori	pag. 312	1272	Alimentatori	pag. 313
1166	Alimentatori	pag. 312	1279	Edera	pag. 236
1167	Alimentatori	pag. 312	1280	Giotto	pag. 261
1168	Alimentatori	pag. 312	1282	Giotto	pag. 266
1169	Alimentatori	pag. 311	1283	Edera	pag. 236
1171	Alimentatori	pag. 311	1284	Edera	pag. 236
1172	Alimentatori	pag. 310-311	1285	Giotto	pag. 261
1178	Alimentatori	pag. 310	1286	Giotto	pag. 266
1179	Alimentatori	pag. 310	1287	Edera	pag. 236
1180	Alimentatori	pag. 311	1288	Edera	pag. 236
1181	Alimentatori	pag. 311	1289	Twin	pag. 172
1182	Alimentatori	pag. 311	1290	Twin	pag. 172
1183	Alimentatori	pag. 311	1291	Twin	pag. 172
1184	Alimentatori	pag. 311	1292	Twin	pag. 172
1185	Alimentatori	pag. 311	1293	Edera	pag. 235
1187	Alimentatori	pag. 313	1294	Edera	pag. 235
1188	Alimentatori	pag. 313	1296	Edera	pag. 235
1197	Alimentatori	pag. 313	1297	Edera	pag. 235
1199	Alimentatori	pag. 313	1300	Alimentatori	pag. 314
1200	Alimentatori	pag. 312	1303	Alimentatori	pag. 314
1201	Alimentatori	pag. 311	1304	Alimentatori	pag. 314
1227	Alimentatori	pag. 315	1305	Alimentatori	pag. 315
1228	Alimentatori	pag. 315	1306	Alimentatori	pag. 314
1240	Alimentatori	pag. 311	1308	Alimentatori	pag. 314
1241	Alimentatori	pag. 311	1309	Alimentatori	pag. 314
1242	Alimentatori	pag. 311	1311	Alimentatori	pag. 314-315
1243	Alimentatori	pag. 311	1312	Alimentatori	pag. 315
1245	Alimentatori	pag. 311	1313	Alimentatori	pag. 310
1246	Alimentatori	pag. 311	1314	Alimentatori	pag. 310
1247	Alimentatori	pag. 311	1410	Twin	pag. 165
1248	Alimentatori	pag. 311	3110	Twin	pag. 162
1250	Alimentatori	pag. 315	3310	Twin	pag. 163
1251	Alimentatori	pag. 310	4019	Slash	pag. 77
1253	Dadajè	pag. 250-256	4021	Slash	pag. 77
1254	Dadajè	pag. 250-256	4024	Slash	pag. 77
1256	Alimentatori	pag. 313	4051	Slash	pag. 82
1257	Alimentatori	pag. 313	4054	Slash	pag. 82
1258	Alimentatori	pag. 310	406122	Slash Dec	pag. 216

406123	Slash Dec	pag. 216	4862	Dadajè	pag. 243	59227	Incrocio	pag. 224
406124	Slash Dec	pag. 216	4863	Dadajè	pag. 243	6061	Alvin	pag. 239
406125	Slash Dec	pag. 216	4871	Dadajè	pag. 248	6062	Alvin	pag. 239
407121	Slash Dec	pag. 215	4872	Dadajè	pag. 248	6063	Alvin	pag. 239
407122	Slash Dec	pag. 215	4882	Dadajè	pag. 249	7003	Edera	pag. 236
407123	Slash Dec	pag. 215	4891	Dadajè	pag. 245	763130	Edera	pag. 229
407124	Slash Dec	pag. 215	4892	Dadajè	pag. 245	763160	Edera	pag. 229
4099	Slash	pag. 79	4893	Dadajè	pag. 245	763530	Edera	pag. 230
4119	Slash	pag. 77	4921	Dadajè	pag. 240	763560	Edera	pag. 230
4121	Slash	pag. 77	4991	Dadajè	pag. 246	763930	Edera	pag. 232
4124	Slash	pag. 77	4992	Dadajè	pag. 246	763960	Edera	pag. 232
4199	Slash	pag. 79	5001	Dadajè	pag. 256	764030	Edera	pag. 232
4219	Mini B-Light	pag. 89	5002	Dadajè	pag. 256	764060	Edera	pag. 232
4221	Mini B-Light	pag. 89	5061	Dadajè	pag. 255	764430	Edera	pag. 230
4224	Mini B-Light	pag. 89	5062	Dadajè	pag. 255	764460	Edera	pag. 230
4248	Mini B-Light	pag. 92	5063	Dadajè	pag. 255	764630	Edera	pag. 230
4249	Mini B-Light	pag. 92	5091	Dadajè	pag. 253	764660	Edera	pag. 230
4250	Mini B-Light	pag. 92	5092	Dadajè	pag. 253	764730	Edera	pag. 229
4251	Mini B-Light	pag. 93	5221	Dadajè	pag. 240	764760	Edera	pag. 229
4256	Mini B-Light	pag. 93	5261	Dadajè	pag. 242	764830	Edera	pag. 229
4299	Mini B-Light	pag. 91	5262	Dadajè	pag. 243	764860	Edera	pag. 229
424819	Mini B-Light	pag. 92	5263	Dadajè	pag. 243	764930	Edera	pag. 232
424821	Mini B-Light	pag. 92	5271	Dadajè	pag. 248	764960	Edera	pag. 232
424824	Mini B-Light	pag. 92	5272	Dadajè	pag. 248	772119	Giotto	pag. 266
424919	Mini B-Light	pag. 92	5282	Dadajè	pag. 249	772219	Giotto	pag. 266
424921	Mini B-Light	pag. 92	5291	Dadajè	pag. 245	772319	Giotto	pag. 266
424924	Mini B-Light	pag. 92	5321	Dadajè	pag. 240	772419	Giotto	pag. 266
425019	Mini B-Light	pag. 92	5391	Dadajè	pag. 246	773219	Giotto	pag. 269
425021	Mini B-Light	pag. 92	5401	Dadajè	pag. 250	775119	Giotto	pag. 259
425024	Mini B-Light	pag. 92	5402	Dadajè	pag. 250	775219	Giotto	pag. 259
4311	Hangar	pag. 45	59121	Incrocio	pag. 222	775319	Giotto	pag. 259
4321	Hangar	pag. 44	59122	Incrocio	pag. 220	775419	Giotto	pag. 259
4322	Hangar	pag. 44	59123	Incrocio	pag. 222	775519	Giotto	pag. 259
4326	Hangar	pag. 45	59124	Incrocio	pag. 220	775619	Giotto	pag. 259
4327	Hangar	pag. 45	59125	Incrocio	pag. 222	775719	Giotto	pag. 259
4350	Hangar	pag. 39	59126	Incrocio	pag. 220	776019	Giotto	pag. 262
4352	Hangar	pag. 39	59127	Incrocio	pag. 224	776119	Giotto	pag. 262
4391	Hangar	pag. 45	59128	Incrocio	pag. 224	776219	Giotto	pag. 265
4392	Hangar	pag. 45	59151	Incrocio	pag. 226	7821	Atlas	pag. 189
4399	Hangar	pag. 39	59152	Incrocio	pag. 226	7821D	Atlas	pag. 189
4451	Triax	pag. 55	59153	Incrocio	pag. 227	7822	Atlas	pag. 189
4499	Triax	pag. 54	59154	Incrocio	pag. 227	7822D	Atlas	pag. 189
4519	Angolare	pag. 99	59161	Incrocio	pag. 218	7823	Atlas	pag. 189
4521	Angolare	pag. 99	59162	Incrocio	pag. 218	7823D	Atlas	pag. 189
4524	Angolare	pag. 99	59221	Incrocio	pag. 222	7824	Atlas	pag. 190
4551	Angolare	pag. 100	59222	Incrocio	pag. 220	7824D	Atlas	pag. 190
4801	Dadajè	pag. 250	59223	Incrocio	pag. 222	7825	Atlas	pag. 190
4802	Dadajè	pag. 250	59224	Incrocio	pag. 220	7825D	Atlas	pag. 190
4830	Dadajè	pag. 246	59225	Incrocio	pag. 222	7826	Atlas	pag. 190
4861	Dadajè	pag. 242	59226	Incrocio	pag. 220	7826D	Atlas	pag. 190

7827	Atlas	pag. 190	8974	Monet	pag. 284	91424	Resinati IP67	pag. 115
7827D	Atlas	pag. 190	8975	Monet	pag. 284	9151	Tau	pag. 67
7828	Atlas	pag. 190	8976	Monet	pag. 286	9152	Tau	pag. 67
7828D	Atlas	pag. 190	8977	Monet	pag. 286	91710	Tau	pag. 64
7829	Atlas	pag. 190	9019	Sigma	pag. 47	91721	Tau	pag. 64
7829D	Atlas	pag. 190	90219	Sigma	pag. 47	91724	Tau	pag. 64
7830	Atlas	pag. 192	9021	Sigma	pag. 47	91819	Tau	pag. 64
7830D	Atlas	pag. 192	90221	Sigma	pag. 47	91821	Tau	pag. 64
7831	Atlas	pag. 192	9024	Sigma	pag. 47	91824	Tau	pag. 64
7831D	Atlas	pag. 192	90224	Sigma	pag. 47	9199	Tau	pag. 66
7832	Atlas	pag. 192	90349	Sigma3	pag. 53	9210	Etha	pag. 118
7832D	Atlas	pag. 192	90350	Sigma3	pag. 53	9224	Etha	pag. 118
7892	Atlas	pag. 192	90399	Sigma3	pag. 52	9298	Etha	pag. 118
7893	Atlas	pag. 192	9047	Sigma	pag. 50	9299	Etha	pag. 118
7894	Atlas	pag. 192	9048	Sigma	pag. 50	930549	Sihon	pag. 75
8021	Tag	pag. 177	9049	Sigma	pag. 50	930550	Sihon	pag. 75
8022	Tag	pag. 177	9050	Sigma	pag. 50	930595	Sihon	pag. 75
8023	Tag	pag. 178	9051	Sigma-Sigma3	pag. 50-53	930595	Resinati IP67	pag. 114
8024	Tag	pag. 178	9052	Sigma-Sigma3	pag. 50-53	930599	Sihon	pag. 75
8025	Tag	pag. 181	905219	Degas	pag. 271	930599	Resinati IP67	pag. 114
8026	Tag	pag. 181	905319	Degas	pag. 271	9319	Sihon	pag. 69
8051	Tag	pag. 182	905519	Degas	pag. 275	9321	Sihon	pag. 69
8052	Tag	pag. 182	905619	Degas	pag. 275	9324	Sihon	pag. 69
812120	Swing	pag. 185	905719	Degas	pag. 273	93410	Resinati IP67	pag. 114
812320	Swing	pag. 185	905819	Degas	pag. 273	93421	Resinati IP67	pag. 114
816120	Swing	pag. 186	906119	Hangar	pag. 40	93424	Resinati IP67	pag. 114
8301	Beta	pag. 293	906121	Hangar	pag. 40	9349	Sihon	pag. 73
8501	Beta	pag. 293	906124	Hangar	pag. 40	9350	Sihon	pag. 73
8511	Beta	pag. 293	906210111	Hangar	pag. 40	9352	Sihon	pag. 73
8530	Beta	pag. 292	906210211	Hangar	pag. 40	9353	Sihon	pag. 74
8661	Modi	pag. 200	906219	Hangar	pag. 40	9354	Sihon	pag. 74
8671	Libro	pag. 199	906221	Hangar	pag. 40	93619	Hangar	pag. 42
8672	Libro	pag. 199	906224	Hangar	pag. 40	93621	Hangar	pag. 42
8673	Libro	pag. 199	906310111	Hangar	pag. 40	9362111	Hangar	pag. 42
8674	Libro	pag. 199	906310211	Hangar	pag. 40	93624	Hangar	pag. 42
8680	Modi	pag. 200	906410111	Hangar	pag. 40	9363111	Hangar	pag. 42
88611	Picasso	pag. 289	906410211	Hangar	pag. 40	9364111	Hangar	pag. 42
88612	Picasso	pag. 289	90699	Hangar	pag. 40	93699	Hangar	pag. 42
88621	Picasso	pag. 290	908019	Degas	pag. 276	93710	Sihon	pag. 70
88622	Picasso	pag. 290	908119	Degas	pag. 276	93721	Sihon	pag. 70
88631	Picasso	pag. 290	908219	Degas	pag. 279	93724	Sihon	pag. 70
88632	Picasso	pag. 290	908220	Degas	pag. 279	93819	Sihon	pag. 70
8944	Monet	pag. 283	908619	Degas	pag. 281	93821	Sihon	pag. 70
8945	Monet	pag. 283	908620	Degas	pag. 281	93824	Sihon	pag. 70
8946	Monet	pag. 283	9099	Sigma	pag. 48	9399	Sihon	pag. 72
8947	Monet	pag. 283	9119	Tau	pag. 63	9448	Slash-B-Light	pag. 80-85
8954	Monet	pag. 284	9121	Tau	pag. 63	944819	Slash	pag. 80
8955	Monet	pag. 284	9124	Tau	pag. 63	944821	Slash	pag. 80
8956	Monet	pag. 286	91410	Resinati IP67	pag. 115	944824	Slash	pag. 80
8957	Monet	pag. 286	91421	Resinati IP67	pag. 115	9449	Slash-B-Light	pag. 80-85

944919	Slash	pag. 80	9654	Sigma-Delta-Sihon	pag. 51-61-73
944921	Slash	pag. 80	9655	Delta-Sihon	pag. 61-74
944924	Slash	pag. 80	9656	Sigma-Delta-Tau- Sihon-Micro - Resinati	pag. 51-61-67-73 97-113 - 115 - 116
9450	Slash-B-Light	pag. 81-85	9657	Hangar-Sigma-Sigma3 Delta-Sihon-Vela	pag. 39-50-53-61 73-103
945019	Slash	pag. 81	9658	Sigma-Sigma3-Delta-Sihon	pag. 51-53-61-73
945021	Slash	pag. 81	9659	Sigma	pag. 51
945024	Slash	pag. 81	9660	Sigma-Sigma3-Triax-Delta Tau-Sihon-Micro-Kappa	pag. 50-53-55-61 67-73-97-104
9451	Kappa	pag. 104	9661	Sigma-Delta-Sihon	pag. 51-61-74
9452	Kappa	pag. 104	9662	Sigma-Delta-Tau-Sihon	pag. 51-61-67-73
9453	Micro	pag. 97	96710	Delta	pag. 58
9454	Micro	pag. 97	96721	Delta	pag. 58
9455	Vela	pag. 103	96724	Delta	pag. 58
9456	B-Light	pag. 86	96819	Delta	pag. 58
9457	Slash-B-Light-Mini B-Light	pag. 82-86-93	96821	Delta	pag. 58
9458	Slash-B-Light-Mini B-Light	pag. 82-86-93	96824	Delta	pag. 58
9459	Slash-B-Light	pag. 82-86	9699	Delta	pag. 60
9463	Slash-B-Light-Mini B-Light	pag. 82-86-93	970	Strip	pag. 125
9491	Piatto	pag. 105	9730	Strip	pag. 124
9492	Piatto	pag. 105	9739	Strip	pag. 124
9493	B-Light	pag. 84	9740	Strip	pag. 124
9494	Vela	pag. 102	9749	Strip	pag. 124
9495	Micro	pag. 97	97803	Strip	pag. 126
949519	Micro	pag. 95	97893	Strip	pag. 126
949521	Micro	pag. 95	979	Strip	pag. 125
949524	Micro	pag. 95	97900	Strip	pag. 126
9495410	Resinati IP67	pag. 116	979020	Strip	pag. 120
9495421	Resinati IP67	pag. 116	979029	Strip	pag. 120
9495424	Resinati IP67	pag. 116	979060	Strip	pag. 121
9499	Kappa	pag. 104	979069	Strip	pag. 121
9551	Omega	pag. 110	97990	Strip	pag. 126
95510	Omega	pag. 107	98210011	Omicron	pag. 19
9552	Omega	pag. 110	98210012	Omicron	pag. 20
95524	Omega	pag. 107	98210014	Omicron	pag. 22
9555	Omega	pag. 110	98210018	Omicron	pag. 22
95610	Omega	pag. 109	98210091	Omicron	pag. 18
95624	Omega	pag. 109	98210092	Omicron	pag. 18
9599	Omega	pag. 110	98210108	Omicron Dec	pag. 203
9619	Delta	pag. 57	98210109	Omicron	pag. 13
9621	Delta	pag. 57	98210111	Omicron	pag. 19
9624	Delta	pag. 57	98210112	Omicron	pag. 20
96410	Resinati IP67	pag. 113	98210113	Omicron	pag. 20
96421	Resinati IP67	pag. 113	98210114	Omicron	pag. 22
96424	Resinati IP67	pag. 113	98210118	Omicron	pag. 22
9649	Delta	pag. 60	98210208	Omicron Dec	pag. 203
9650	Delta	pag. 61	98210209	Omicron	pag. 13
9651	Delta	pag. 60	98210211	Omicron	pag. 19
9652	Delta	pag. 60	98210212	Omicron	pag. 20
9653	Hangar-Sigma-Sigma3- Delta-Tau-Sihon-Vela	pag. 39-50-53-61 67-73-103			
96532	Angolare	pag. 100			

98210113	Omicron	pag. 20	98410108	Omicron Dec	pag. 203
98210114	Omicron	pag. 22	98410109	Omicron	pag. 13
98210118	Omicron	pag. 22	98410111	Omicron	pag. 19
98210208	Omicron Dec	pag. 203	98410112	Omicron	pag. 20
98210209	Omicron	pag. 13	98410113	Omicron	pag. 20
98210211	Omicron	pag. 19	98410114	Omicron	pag. 22
98210212	Omicron	pag. 20	98410118	Omicron	pag. 22
98210213	Omicron	pag. 20	98410208	Omicron Dec	pag. 203
98210214	Omicron	pag. 22	98410209	Omicron	pag. 13
98210218	Omicron	pag. 22	98410211	Omicron	pag. 19
98211908	Omicron Dec	pag. 206	98410212	Omicron	pag. 20
98211909	Omicron	pag. 15	98410213	Omicron	pag. 20
98212008	Omicron Dec	pag. 206	98410214	Omicron	pag. 22
98212009	Omicron	pag. 15	98410218	Omicron	pag. 22
98212108	Omicron Dec	pag. 205	984801	Omicron	pag. 17
98212109	Omicron	pag. 15	984802	Omicron	pag. 17
98212208	Omicron Dec	pag. 205	9851	Omicron	pag. 18-32
98212209	Omicron	pag. 15	98510011	Omicron	pag. 33
98212308	Omicron Dec	pag. 205	98510014	Omicron	pag. 34
98212309	Omicron	pag. 15	98510018	Omicron	pag. 34
98212408	Omicron Dec	pag. 205	98510091	Omicron	pag. 32
98212409	Omicron	pag. 16	98510092	Omicron	pag. 32
98212508	Omicron Dec	pag. 206	98510108	Omicron Dec	pag. 209
98212509	Omicron	pag. 16	98510109	Omicron	pag. 26
98212609	Omicron	pag. 16	98510111	Omicron	pag. 33
98212709	Omicron	pag. 16	98510114	Omicron	pag. 34
98212809	Omicron	pag. 17	98510118	Omicron	pag. 34
98212909	Omicron	pag. 17	98510208	Omicron Dec	pag. 209
98213208	Omicron Dec	pag. 207	98510209	Omicron	pag. 26
98310108	Omicron Dec	pag. 203	98510211	Omicron	pag. 33
98310109	Omicron	pag. 13	98510214	Omicron	pag. 34
98310111	Omicron	pag. 19	98510218	Omicron	pag. 34
98310112	Omicron	pag. 20	98511108	Omicron Dec	pag. 209
98310113	Omicron	pag. 20	98511109	Omicron	pag. 26
98310114	Omicron	pag. 22	98511208	Omicron Dec	pag. 209
98310118	Omicron	pag. 22	98511209	Omicron	pag. 26
98310208	Omicron Dec	pag. 203	98511909	Omicron	pag. 30
98310209	Omicron	pag. 13	98512009	Omicron	pag. 30
98310211	Omicron	pag. 19	98512109	Omicron	pag. 29
98310212	Omicron	pag. 20	98512209	Omicron	pag. 29
98310213	Omicron	pag. 20	98512309	Omicron	pag. 29
98310214	Omicron	pag. 22	98512409	Omicron	pag. 29
98310218	Omicron	pag. 22	98512509	Omicron	pag. 30
98410108	Omicron Dec	pag. 203	98512609	Omicron	pag. 31
98410109	Omicron	pag. 13	98512709	Omicron	pag. 31
98410111	Omicron	pag. 19	9852	Omicron	pag. 18-32
98410112	Omicron	pag. 20	9853	Omicron	pag. 18
98410113	Omicron	pag. 20	9854	Omicron	pag. 18
98410114	Omicron	pag. 22	9857	Omicron-Slash	pag. 32-82
98410118	Omicron	pag. 22	9858	Omicron	pag. 32

98610121	Omicron Dec	pag. 211
98610122	Omicron Dec	pag. 211
98610123	Omicron Dec	pag. 211
98610124	Omicron Dec	pag. 212
98610125	Omicron Dec	pag. 212
98610221	Omicron Dec	pag. 211
98610222	Omicron Dec	pag. 211
98610223	Omicron Dec	pag. 211
98610224	Omicron Dec	pag. 212
98610225	Omicron Dec	pag. 212
98611121	Omicron Dec	pag. 211
98611122	Omicron Dec	pag. 211
98611123	Omicron Dec	pag. 211
98611124	Omicron Dec	pag. 212
98611125	Omicron Dec	pag. 212
98611221	Omicron Dec	pag. 211
98611222	Omicron Dec	pag. 211
98611223	Omicron Dec	pag. 211
98611224	Omicron Dec	pag. 212
98611225	Omicron Dec	pag. 212
9862	Omicron Dec	pag. 211 - 212
98710108	Omicron Dec	pag. 209
98710109	Omicron	pag. 26
98710111	Omicron	pag. 33
98710114	Omicron	pag. 34
98710118	Omicron	pag. 34
98710208	Omicron Dec	pag. 209
98710209	Omicron	pag. 26
98710211	Omicron	pag. 33
98710214	Omicron	pag. 34
98710218	Omicron	pag. 34
98711108	Omicron Dec	pag. 209
98711109	Omicron	pag. 26
98711208	Omicron Dec	pag. 209
98711209	Omicron	pag. 26
98810108	Omicron Dec	pag. 209
98810109	Omicron	pag. 26
98810111	Omicron	pag. 33
98810114	Omicron	pag. 34
98810118	Omicron	pag. 34
98810208	Omicron Dec	pag. 209
98810209	Omicron	pag. 26
98810211	Omicron	pag. 33
98810214	Omicron	pag. 34
98810218	Omicron	pag. 34
98811108	Omicron Dec	pag. 209
98811109	Omicron	pag. 26
98811208	Omicron Dec	pag. 209
98811209	Omicron	pag. 26
9895	Omicron	pag. 18-32-203 - 209

9896	Sigma	pag. 47-50
990	Strip	pag. 125
999	Strip	pag. 125
9910	Strip	pag. 125
9919	Strip	pag. 125
996710	Strip	pag. 127
996724	Strip	pag. 127
999030	Strip	pag. 122
999039	Strip	pag. 122
999040	Strip	pag. 122
999049	Strip	pag. 122
999050	Strip	pag. 123

 **ATHENA**
così in luce

Condizioni di vendita

I colori delle fotografie degli articoli, i grafici e le quote riportati nel presente catalogo si intendono a titolo indicativo.

Athena srl si riserva la facoltà di modificare le caratteristiche tecniche ed estetiche dei prodotti senza alcun preavviso, al fini di apportare migliorie ai propri articoli. Il catalogo è tutelato dalla legge del diritto di autore e pertanto, ne è vietata la riproduzione anche parziale.

Sales Conditions

The colours of the photographs of the articles, the graphs and the amount quoted in this catalogue are only indicative.

Athena reserves the right to make any modification to the technical and aesthetic characteristics of the products without any forewarning, in order to improve its articles.

The catalogue is protected by the law of copyright and, therefore, it is forbidden to copy it, even partially.



Via Varesina, 36 - 22078 Turate (CO)
T +39 02 96480755
info@athenainluce.it
amministrazione@athenainluce.it
commerciale@athenainluce.it
www.athenainluce.eu

